



**National
Construction
Code**

Apartment energy efficiency

Handbook



**Australian
Building
Codes Board**



The Australian Building Codes Board

The Australian Building Codes Board (ABCBC) is a standards writing body responsible for the National Construction Code (NCC), WaterMark and CodeMark Certification Schemes.

The ABCBC is a joint initiative of all levels of government in Australia, together with the building and plumbing industry. Its mission is to oversee issues relating to health, safety, amenity, accessibility and sustainability in building.

For more information visit the [ABCBC website](#).

Copyright

© Commonwealth of Australia and the States and Territories of Australia 2023, published by the Australian Building Codes Board.

This work is licensed under the Creative Commons Attribution 4.0 International License. More information on this licence is set out at the [Creative Commons website](#).

Unless otherwise noted, copyright (and any other intellectual property rights, if any) in this publication is jointly owned by the Commonwealth, States and Territories of Australia.



Attribution

Use of all or part of this publication must include the following attribution:

The Apartment energy efficiency Handbook was provided by the [Australian Building Codes Board](#) under the [CC BY 4.0](#) licence.

Disclaimer

By accessing or using this publication, you agree to the following:

While care has been taken in the preparation of this publication, it may not be complete or up-to-date. You can ensure that you are using a complete and up-to-date version by checking the [ABCBC website](#).

The ABCBC, the Commonwealth of Australia and States and Territories of Australia do not accept any liability, including liability for negligence, for any loss (howsoever caused), damage, injury, expense or cost incurred by any person as a result of accessing, using or relying upon this publication, to the maximum extent permitted by law. No representation or warranty is made or given as to the currency, accuracy, reliability, merchantability, fitness for any purpose or completeness of this publication or any information which may appear on any linked websites, or in other linked information sources, and all such representations and warranties are excluded to the extent permitted by law.

This publication is not legal or professional advice. Persons rely upon this publication entirely at their own risk and must take responsibility for assessing the relevance and accuracy of the information in relation to their particular circumstances.

Version history

Original

Publish date: Dec 2023

Print version: 1.0



Preface

This handbook is one of a series by the ABCB. Handbooks expand on areas of existing regulation or relate to topics that are not regulated by the NCC. They provide advice and guidance.

The Apartment energy efficiency handbook assists in understanding the energy efficiency provisions in NCC Volume One that apply to Class 2 apartment buildings. This includes the sole-occupancy units (SOUs) and common areas of Class 2 apartment buildings.

It addresses issues in generic terms and is not a document that sets out specific compliance advice for developing solutions to comply with the requirements in the NCC. It is expected that this handbook guides readers to develop solutions relevant to specific situations in accordance with the generic principles and criteria contained herein.



Contents

1 Introduction.....	1
1.1 Background.....	1
1.2 Scope.....	2
1.3 Using this document.....	3
2 Performance Requirements and compliance options	5
2.1 Introduction.....	5
2.2 Objective and Functional Statement	5
2.3 Performance Requirements.....	6
2.4 Compliance options	11
3 Compliance options for an SOU (J1P2 and J1P3).....	15
3.1 Compliance Option 1: NatHERS.....	15
3.2 Compliance Option 2: Elemental	43
3.3 Compliance Option 3: J1V5 Verification using a reference building.....	90
3.4 Compliance Option 4: J1V4 Verification of building envelope sealing	101
3.5 Compliance Option 5: Other Performance Solutions	105
4 Compliance options for common areas (J1P1 and J1P4)	110
4.1 Compliance Option 1: Elemental	110
4.2 Compliance Option 2: J1V1 NABERS Energy.....	145
4.3 Compliance Option 3: J1V2 Green Star.....	152
4.4 Compliance Option 4: J1V3 Verification using a reference building.....	158
4.5 Compliance Option 5: J1V4 Verification of building envelope sealing	167
4.6 Compliance Option 6: Other Performance Solutions	171
Appendix A Abbreviations.....	177
Appendix B Glossary	179
Appendix C Compliance with the NCC.....	197
C.1 Responsibilities for regulation of building and plumbing in Australia.....	197
C.2 Demonstrating compliance with the NCC	197
Appendix D Examples for an SOU	200
D.1 Heating and cooling load limits.....	201
D.2 Building fabric.....	203
D.3 Glazing	208
D.4 Ceiling fans.....	214
D.5 WOH energy usage	216
D.6 Artificial lighting.....	221



D.7 J1V4 Verification of building envelope sealing.....224
Appendix E Examples for common areas.....227
E.1 Building fabric.....228
E.2 Ductwork insulation.....238
E.3 Water pump240
E.4 Artificial lighting.....243
E.5 J1V3 Verification using a reference building247
Appendix F Relevant reports and standards249



1 Introduction

1.1 Background

1.1.1 The NCC

The NCC is a performance-based code containing all Performance Requirements for the construction of buildings. To comply with the NCC, a solution must achieve compliance with the Governing Requirements and the Performance Requirements. These are the mandatory parts of the NCC.

The Governing Requirements contain requirements about how the Performance Requirements must be met. A building, plumbing or drainage solution will comply with the NCC if it satisfies the Performance Requirements.

1.1.2 Apartment energy efficiency requirements

Apartment energy efficiency requirements were first introduced into the Building Code of Australia (BCA) in 2006. As a result of government policy initiatives¹, major changes to these requirements occurred in 2010, 2019 and more recently 2022. The apartment energy efficiency requirements cover:

- individual apartments (sole-occupancy units (SOUs))
- the common areas of an apartment building (Class 2 building).

When compared to NCC 2019 there are 5 main changes to the energy efficiency requirements for an apartment building in NCC 2022. These include:

- changes to the clause numbering due to the introduction of a consistent volume structure (CVS) across all 3 volumes of the NCC.
- two new quantified² Performance Requirements for SOUs.
- two new compliance pathways for SOUs.
- an increase in thermal performance (building fabric) stringency for an SOU and requirements to regulate the 'energy value'³ of an SOU with typical fixed appliance use.

¹ Policy initiatives include the [National Strategy on Energy Efficiency](#), [National Energy Productivity Plan](#), and the [Trajectory for Low Energy Buildings](#).

² 'Quantified' means the Performance Requirements primarily contain numerical targets that clarify the level of performance required.

³ See the Glossary at Appendix B for the definition of 'energy value'



- a new Performance Requirement and DTS Provisions to facilitate electric vehicle (EV) charging and renewable energy equipment.

The overall intent of the apartment energy efficiency requirements is to:

- reduce energy consumption and energy peak demand
- reduce greenhouse gas emissions
- improve occupant health and amenity.

1.1.3 Energy efficiency handbooks

Alongside other guidance and support materials available from the [ABCB website](#), there will be a new series of energy efficiency handbooks. These new handbooks are intended to assist NCC users to understand and comply with the latest requirements.

The new handbooks:

- focus on available compliance options
- are easier-to-digest documents than previous handbooks on energy efficiency
- provide links to other guidance and support materials
- consider the needs of various types of practitioners.

The Apartment Energy Efficiency Handbook is the second handbook in the new series of energy efficiency handbooks.

1.2 Scope

To specify particular requirements for different types of buildings, the NCC uses a building classification system. Building classifications are labelled 'Class 1' through to 'Class 10'. Some classifications also have sub-classifications, referred to by a letter after the number (e.g. Class 1a).

The scope of this document is limited to Class 2 buildings. Class 2 buildings typically consist of multiple residential dwellings with multiple storeys. For simplicity, this handbook uses the term 'apartment building' for a Class 2 building and 'SOU' to refer to an individual apartment (dwelling) in a Class 2 building. A Class 4 part of a building is not discussed, except where referred to specifically in the NCC itself, for example in the title of a Performance Requirement or in an NCC extract

More information on building classifications and access to the NCC is available from the [ABCB website](#). See Figure 1.1 to understand the structure of the NCC.



Figure 1.1 How the NCC is structured

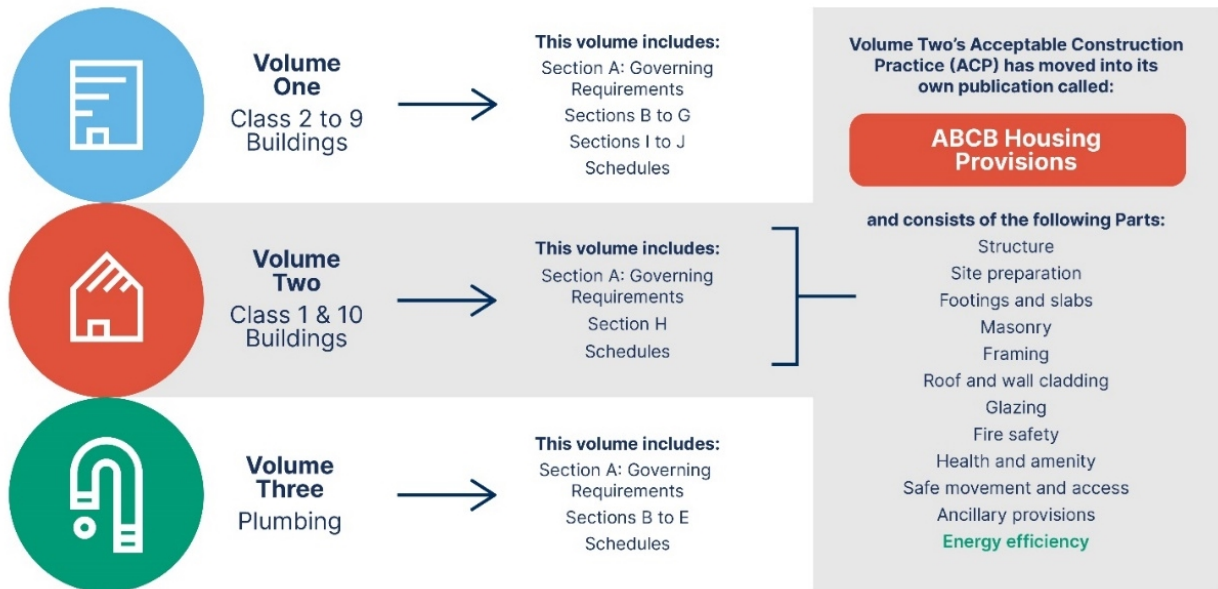

1.3 Using this document

1.3.1 Structure

Chapter 2 provides an overview of the Performance Requirements for apartment energy efficiency and the compliance options that can be used.

Chapter 3 describes the compliance options for an SOU, whereas Chapter 4 describes the compliance options for the common areas of an apartment building. This enables the reader to focus on the compliance option(s) they will likely use to meet the Performance Requirements.

For each compliance option there is an introduction, a method (that includes the key requirements), useful tips, information on demonstrating compliance and typically one or more examples.

1.3.2 Appendices

This document contains 6 appendices, as follows:

- Appendix A contains a list of abbreviations used in this document
- Appendix B is a glossary of key terms used in this document
- Appendix C provides general information about complying with the NCC and responsibilities for building and plumbing regulations



- Appendix D contains examples for an SOU
- Appendix E contains examples for common areas
- Appendix F provides a list of relevant reports and standards.

1.3.3 Document styles

Different styles are used in this document. Examples of these styles are below.

NCC extracts⁴

Examples

Alerts or Reminders

⁴ NCC extracts italicise defined terms as per the NCC. See Schedule 1 of the NCC for further information.



2 Performance Requirements and compliance options

2.1 Introduction

The Performance Requirements for apartment energy efficiency are located in Section J Energy efficiency of NCC Volume One. They are listed in Table 2.1 below. These Performance Requirements are discussed further in this chapter.

Table 2.1 Energy efficiency Performance Requirements

J1P1	Energy use
J1P2	Thermal performance of a sole-occupancy-unit of a Class 2 building or a Class 4 part of building
J1P3	Energy usage of a sole-occupancy unit of a Class 2 building or a Class 4 part of a building
J1P4	Renewable energy and electric vehicle charging

2.2 Objective and Functional Statement

Objectives and Functional Statements are used in the NCC to provide guidance on the intent and interpretation of the Performance Requirements. For apartment energy efficiency, they are provided with the Performance Requirements in Part J1 of NCC Volume One.

Compared to NCC 2019, the Objective and Functional Statement for apartment energy efficiency have been expanded to align with policy set by governments in the [Trajectory for Low Energy Buildings](#). Objective J1O1 is outlined below.

J1O1 Objective

The Objective of this Part is to –

- (a) reduce energy consumption and energy peak demand; and
- (b) reduce greenhouse gas emissions; and
- (c) improve occupant health and amenity.

The Functional Statement, J1F1 Energy efficiency, applies to an apartment building. An extract of J1F1 is provided below.



J1F1 Energy efficiency

A building must —

- (a) reduce the energy consumption and energy peak demand of key energy using equipment; and
- (b) reduce greenhouse gas emissions that occur as a result of a building's energy consumption and energy source; and
- (c) for a *sole-occupancy unit* of a Class 2 building or a Class 4 part of a building, improve occupant health and *amenity* by mitigating the impact of extreme hot and cold weather events, and energy blackouts.
- (d) for other than in a *sole-occupancy unit* of a Class 2 building or a Class 4 part of a building, protect occupant health and *amenity* by ensuring the building *envelope* assists in the maintenance of acceptable internal conditions while the building is occupied; and
- (e) be able to accommodate the future installation of distributed energy resources.

2.3 Performance Requirements

2.3.1 Performance Requirements for an apartment building

There are 4 mandatory Performance Requirements. The following table outlines which Performance Requirements apply to an SOU and to the common areas of an apartment building.

Table 2.2 Performance Requirements

Performance Requirement	Applies to an SOU?	Applies to the common areas of an apartment building?
J1P1 Energy use	No	Yes
J1P2 Thermal performance of an SOU of a Class 2 building or a Class 4 part of building	Yes	No
J1P3 Energy usage of an SOU of a Class 2 building or a Class 4 part of a building	Yes	No
J1P4 Renewable energy and electric vehicle charging	Yes	Yes



2.3.2 J1P1 Energy usage

J1P1 (JP1 in NCC 2019) is the key Performance Requirement for the efficient use of energy for commercial buildings. An extract of J1P1 is shown below.

J1P1 Energy usage

A building, other than a *sole-occupancy unit* of a Class 2 building or a Class 4 part of a building, including its *services*, must have features that facilitate the efficient use of energy appropriate to—

- (a) the function and use of the building; and
- (b) the level of human comfort required for the building use; and
- (c) solar radiation being
 - utilised for heating; and
 - controlled to minimise energy for cooling; and
- (d) the energy source of the *services*, and
- (e) the sealing of the building *envelope* against air leakage; and
- (f) for a *conditioned space*, achieving an hourly *regulated energy* consumption, averaged over the annual *hours of operation*, of not more than—
 - (i) for a Class 6 building, 80 kJ/m².hr, and
 - (ii) for a Class 5, 7b, 8 or 9a building other than *ward area* or a Class 9b *school*, 43 kJ/m².hr, and
 - (iii) for all other building classifications, 15 kJ/m².hr.

J1P1 applies to the common areas of an apartment building, and other commercial building types. It also explicitly excludes an SOU of a Class 2 apartment building since an SOU is covered by J1P2 and J1P3.

2.3.3 J1P2 Thermal performance of an SOU of a Class 2 building or a Class 4 part of a building

J1P2 is a new Performance Requirement for NCC 2022. It mirrors Performance Requirement H6P1 for Class 1 buildings in NCC Volume Two.

J1P2 contains quantified values and covers the fabric thermal performance of an SOU. The fabric of an SOU includes the external roof, floors, opaque walls and glazing. An extract of J1P2 is shown below.



J1P2 Thermal performance of a sole-occupancy unit of a Class 2 building or a Class 4 part of a building

- (a) The total *heating load* of the *habitable rooms* and *conditioned spaces* in a *sole-occupancy unit* of a Class 2 building or a Class 4 part of a building must not exceed the *heating load limit* in Specification 44.
- (b) The total *cooling load* of the *habitable rooms* and *conditioned spaces* in a *sole-occupancy unit* of a Class 2 building or a Class 4 part of a building must not exceed the *cooling load limit* in Specification 44.
- (c) The total *thermal energy load* of the *habitable rooms* and *conditioned spaces* in a *sole-occupancy unit* of a Class 2 building or a Class 4 part of a building must not exceed the *thermal energy load limit* in Specification 44.

J1P2 regulates the maximum (or upper limit) of permitted heating loads, cooling loads and total thermal energy loads of an SOU⁵.

Many factors contribute to heating and cooling loads, including insulation levels, solar gain, airtightness and the local climate.

Alert

The heating load, cooling load and total thermal energy load limits specified by J1P2 for an SOU are not the same as the actual amount of energy used for heating and cooling.

The amount of energy used for heating and cooling depends on the source of the energy used (i.e. fuel type) and the efficiency of the heating and cooling equipment.

The amount of energy used for heating and cooling by an SOU is addressed by J1P3 Energy usage of an SOU of an apartment building or Class 4 part of a building.

Performance Requirement J1P2 references Specification 44 (new for NCC 2022) to specify the heating load limit, cooling load limit and thermal energy load limit. Specification 44 is in NCC Volume Two, Section H.

Use of the calculation method in Specification 44 is not required in most cases, except where a Performance Solution that references the limits is developed using a first-principles approach (i.e. direct assessment against the Performance Requirements). Compliance options that can be used to meet this Performance Requirement are discussed in section 2.4.

⁵ See the NCC defined terms 'heating load', 'cooling load' and 'thermal energy load' in the Glossary at Appendix B for more information.



2.3.4 J1P3 Energy usage of a SOU of a Class 2 building or a Class 4 part of a building

J1P3 is a new Performance Requirement for NCC 2022. This requirement covers the energy use of an SOU's domestic services. J1P3 has been included in NCC 2022 to:

- better regulate the energy usage of the domestic services of an SOU
- provide quantified, benchmarked levels of performance for some of the domestic services of an SOU.

This Performance Requirement mirrors H6P2 Energy usage in NCC Volume Two for houses. However, for an SOU in an apartment building the energy value is larger than for a detached house. This is because apartment buildings usually face greater constraints than detached houses on the installation of solarvoltaic panels to offset their energy costs.

The benchmark levels of performance for domestic services are predominantly stated in terms of [Greenhouse and Energy Minimum Standards \(GEMS\)](#).

An extract of J1P3 is shown below.

J1P3 Energy usage of a sole-occupancy unit of a Class 2 building or a Class 4 part of a building

- (1) The *energy value* of the *domestic services* of a *sole-occupancy unit* of a Class 2 building or Class 4 part of a building must not exceed the *energy value* with—
 - (a) a 3-star ducted heat pump, rated under the 2019 GEMS determination, heating all spaces that are provided with heating; and
 - (b) a 3-star ducted heat pump, rated under the 2019 GEMS determination, cooling all spaces that are provided with cooling; and
 - (c) a 5-star instantaneous gas water heater, rated under the 2017 GEMS determination, providing all domestic hot water; and
 - (d) a lighting power density of 4 W/m² serving all internal spaces that are provided with artificial lighting.

Domestic services, including any associated distribution system and components must, to the degree necessary, have features that facilitate the efficient use of energy appropriate to—

- (a) the *domestic service* and its usage; and
- (b) the geographic location of the building; and
- (c) the location of the *domestic service*; and
- (d) the energy sources.



Simply put, an SOU will comply with J1P3 if it has an overall 'energy value'⁶ of less than or equal to what is specified in J1P3(1), and also complies with the qualitative requirements of J1P3(2).

Calculating the 'energy value' to comply with J1P3 is not required in most cases, except where a Performance Solution that uses an energy value is developed using a first-principles approach. Compliance options that can be used to meet this Performance Requirement are discussed in section 2.4.

Alert

All relevant NCC Performance Requirements need to be met to achieve compliance with the NCC, as per clause A2G1 of the Governing Requirements. This means both J1P2 and J1P3 need to be met in full for an SOU, with no reduction or trading of performance between Performance Requirements permitted.

Alert

There is no allowance in J1P3 for pool and spa pumps. However, the energy use of an SOU's pool or spa still needs to be taken into account when determining compliance with J1P3. Compliance can be achieved by offsetting the energy use of the pool or spa with more efficient equipment or on-site photovoltaics. Cooking appliances and other appliances like computers and TVs are excluded.

2.3.5 J1P4 Renewable energy and electric vehicle charging

J1P4 Renewable energy and electric vehicle charging is a new Performance Requirement for NCC 2022.

The intent is to enable the future installation of on-site renewable energy generation and storage, as well as electric vehicle charging equipment. An extract of J1P4 is shown below.

J1P4 Renewable energy and electric vehicle charging

A building must have features that facilitate the future installation of on-site renewable energy generation and storage and electric vehicle charging equipment.

⁶ See the NCC defined term 'energy value' in the Glossary at Appendix B for more information.



2.4 Compliance options

2.4.1 Compliance with the NCC

Compliance with the NCC is achieved by complying with the NCC Governing Requirements and relevant Performance Requirements. There are 3 types of solutions available to demonstrate compliance with the Performance Requirements:

- A Performance Solution.
- A Deemed-to-Satisfy (DTS) Solution.
- A combination of a Performance Solution and a DTS Solution.

General information on compliance with the NCC is contained in Appendix C.

2.4.2 Overview of compliance options for an SOU

There are several compliance options available for an SOU to meet one, both or part of the relevant energy efficiency Performance Requirements, J1P2 and J1P3. A simplified overview⁷ of these compliance options is provided in Figure 2.1.

Figure 2.1 Simplified overview of compliance options for an SOU

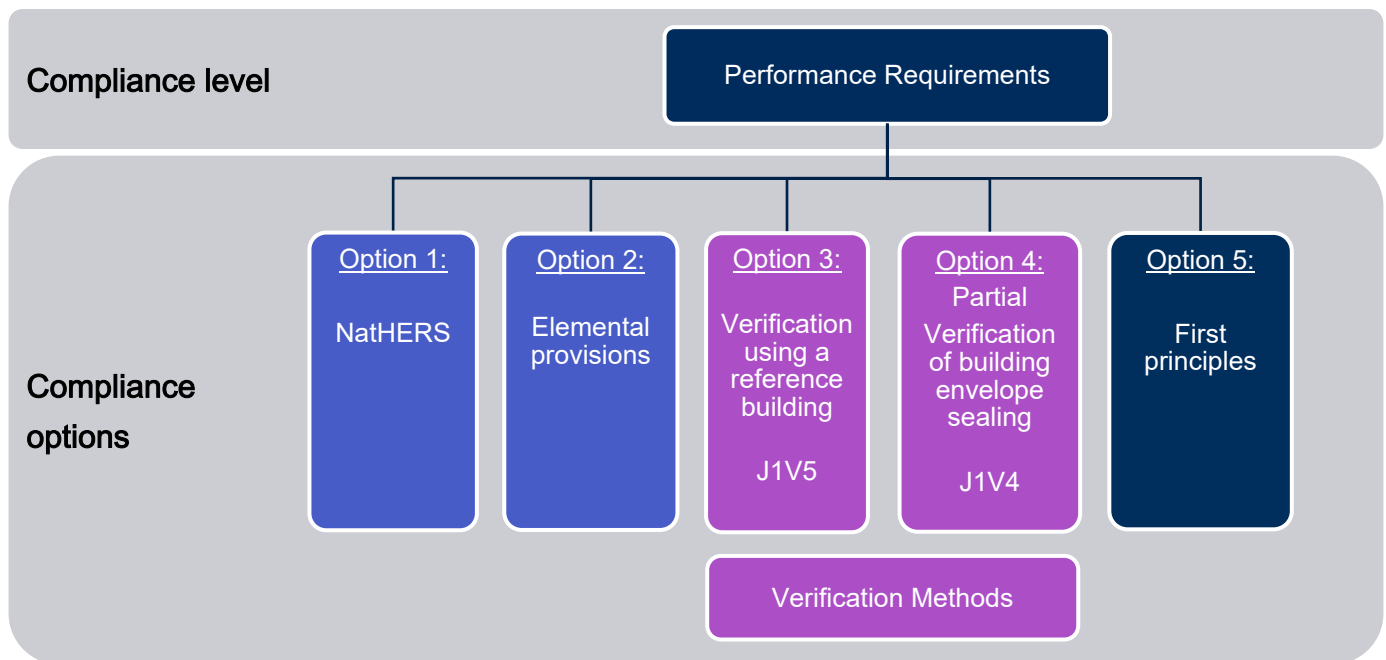

Notes to Figure 2.1:

(1) Blue shading indicates a DTS Solution, while purple shading indicates a Performance Solution.

⁷ This figure provides a simplified overview of compliance options and does not include where a NatHERS software tool has been used to comply with J1P2 and the elemental provisions used to comply with J1P3 for an SOU. See NCC Volume One for more information.



(2) Option 4 only provides partial compliance with the Performance Requirements for SOUs.

Alert

The NatHERS compliance option includes 2 ratings: a thermal rating and a WOH rating.

The thermal rating requires an average 7-star rating of all SOUs in an apartment building, and a minimum of 6 stars for any individual SOU in an apartment building.

The WOH rating is more holistic. It assesses equipment efficiencies and any offsets from on-site renewable energy. It is required that each SOU achieve a score of not less than 50 out of 100.

Additional guidance on available compliance options for different Performance Requirements is provided in Table 2.3.

Table 2.3 Compliance options for an SOU

Options	Type of solution	J1P2	J1P3	Chapter reference
NatHERS	DTS Solution	Y	Y	Chapter 3.1
Elemental	DTS Solution	Y	Y	Chapter 3.2
J1V5 Verification using a reference building	Performance Solution	Y	Y	Chapter 3.3
J1V4 Verification of building envelope sealing	Performance Solution	Y _{partial}	N	Chapter 3.4
Other Performance Solutions	Performance Solution	Y	Y	Chapter 3.5



Alert

A key principle underpinning the NCC 2022 apartment energy efficiency requirements is that all compliance options aim to offer an equivalent level of performance. This principle helps ensure the policy objectives set out in Objective J1O1 (see section 2.2) are achieved.

2.4.3 Overview of compliance options for the common areas of an apartment building

There are several compliance options available for the common areas of an apartment building to meet one, both or part of the relevant energy efficiency Performance Requirements, J1P1 and J1P4. A simplified overview of the available options is provided in Figure 2.2.

Figure 2.2 Simplified overview of compliance options for the common areas of an apartment building

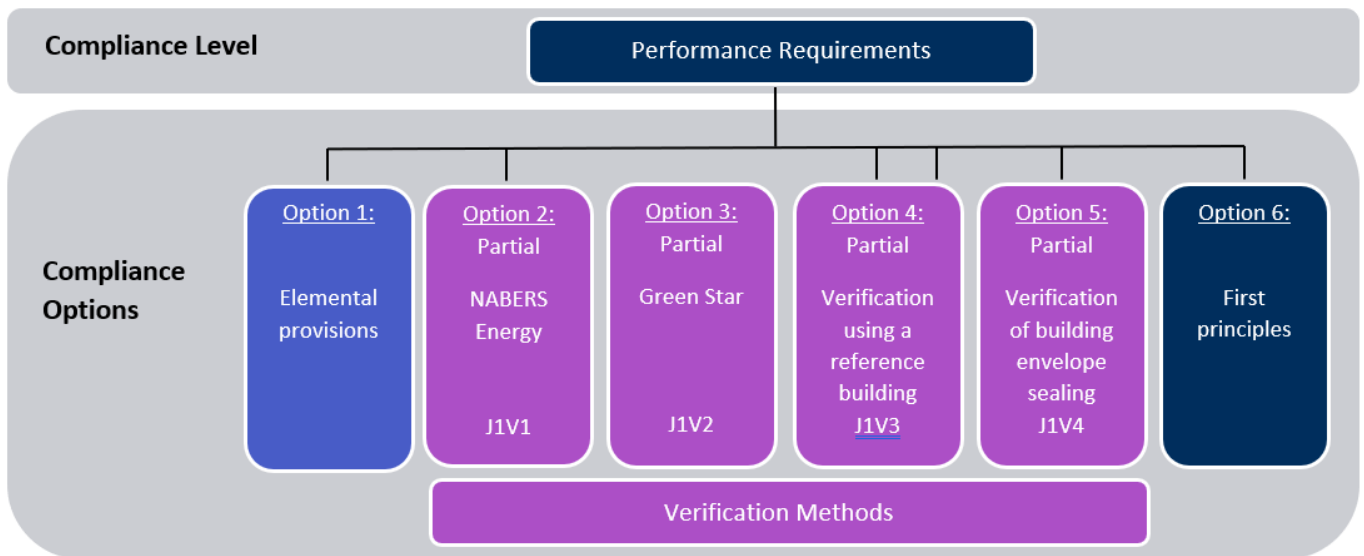

Notes to Figure 2.2:

- (1) Blue shading indicates a DTS Solution, purple shading indicates a Performance Solution (including associated Verification Methods).
- (2) 'Partial' means that a compliance option only partly meets the relevant Performance Requirements, and additional compliance options will need to be used to achieve full compliance with the relevant Performance Requirements.



Table 2.4 Compliance options for the common areas of an apartment building

Options	Type of solution	J1P2	J1P3	Chapter reference
NatHERS	DTS Solution	Y	Y	Chapter 3.1
Elemental	DTS Solution	Y	Y	Chapter 3.2
J1V5 Verification using a reference building	Performance Solution	Y	Y	Chapter 3.3
J1V4 Verification of building envelope sealing	Performance Solution	Y _{partial}	N	Chapter 3.4
Other Performance Solutions	Performance Solution	Y	Y	Chapter 3.5

Alert

Centralised heated water systems in Class 2 apartment buildings do not have a DTS pathway in NCC 2022. A Performance Solution must be developed if a centralised heated water system is to be used for an apartment building. For example, the Performance Solution could be based on either a first principles approach or be verified through the Verification Method J1V5 Verification using a reference building.



3 Compliance options for an SOU (J1P2 and J1P3)

3.1 Compliance Option 1: NatHERS

3.1.1 Introduction

The NatHERS compliance option is a set of DTS Provisions that can be used to meet both energy efficiency Performance Requirements for an SOU of an apartment building, i.e. J1P2 and J1P3.

Alert

NatHERS is a scheme administered by the Australian Government on behalf of all states and territories that facilitates consistent energy ratings from NatHERS accredited software tools for new⁸ Australian homes. More information is available from [NatHERS](#).

The DTS Provisions that form the NatHERS compliance option are used to demonstrate NCC compliance using a DTS Solution. See Appendix C for more information on how to comply with the NCC. This compliance option is in the DTS Provisions of NCC Volume One clauses J2D2(2)(a), J2D2(3)(a)(ii) and J2D2(3)(b) and (c).

Compared to NCC 2019, there are 5 key changes to this compliance option for NCC 2022.

- (1) Changes to the clause numbering due to the CVS.
- (2) An increase in stringency to the average thermal (star) rating of all SOUs, from 6 to 7 stars, which includes changes to the heating and cooling load limits.
- (3) An increase in stringency to the minimum thermal rating for an SOU from 5 to 6 stars, which again includes changes to the heating and cooling load limits.
- (4) Introduction of a Whole of home⁹ (WOH) rating requirement to meet the new Performance Requirement J1P3.
- (5) Introduction of Clause A5G9 in the NCC Governing Requirements that requires evidence of a NatHERS software tool output being in the form of a NatHERS certificate issued in accordance with the NatHERS scheme.

⁸ 'New' includes proposed new homes and SOUs in an apartment building and proposed 'new building work' to existing homes and SOUs in an apartment building. What constitutes 'new building work' is the responsibility of individual jurisdictions.

⁹ Note NatHERS uses 'Whole of Home' (no hyphens, upper case 'H' for home) for its WOH software tools, whereas the NCC uses 'Whole-of-home' (hyphens, lower case 'h' for home). Both NatHERS and the NCC use the same abbreviation which is 'WOH'



Alert

Figure 2.1 and Table 2.3 in Chapter 2 provide a simplified overview of compliance options, noting a combination of DTS Solutions is permitted. For example, NatHERS could be used to meet J1P2 and the Elemental provisions used to meet J1P3.

3.1.2 Method

The NatHERS method provides a compliance pathway that utilises computer simulation, since this aids in the development of unique and optimised solutions.

The NatHERS compliance option references:

- Clause A5G9 and various DTS Provisions in NCC Volume One
- software accredited under NatHERS
- the ABCB Standard for NatHERS heating and cooling load limits (2022).

Figure 3.1 outlines the relevant requirements that form the NatHERS compliance option. Each of these requirements is discussed in further detail in this section.

Figure 3.1 NatHERS compliance option for an SOU

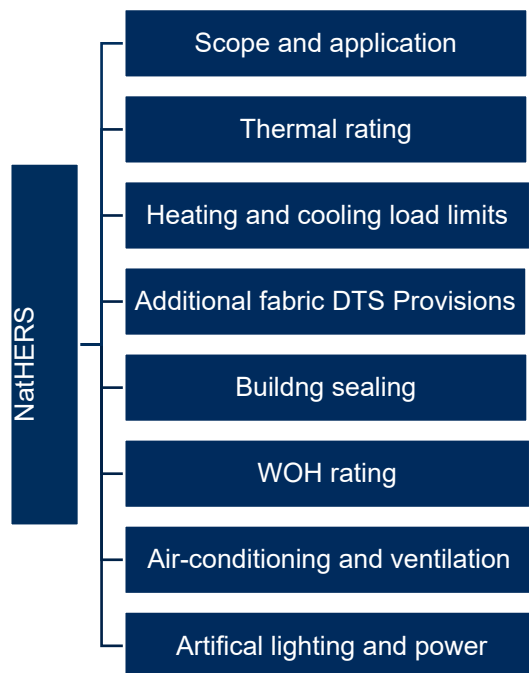



Reminder

The NatHERS compliance option includes 2 ratings: a thermal rating and a WOH rating.

The thermal rating requires an average 7 star rating of all SOUs in a Class 2 building, and a minimum of 6 stars for any individual SOU in a Class 2 building.

The WOH rating is more holistic. It assesses equipment efficiencies and any offsets from on-site renewable energy. It is required that each SOU to achieve a score of not less than 50 of 100.

3.1.2.1 Scope and application

A5G9 and J2D2 of NCC Volume One together specify the scope and application of the NatHERS compliance option.

3.1.2.2 Thermal rating

SOUs are required to collectively achieve an average energy rating greater than or equal to 7 stars using a software tool accredited under NatHERS; and to individually achieve an energy rating of not less than 6 stars. This requirement is specified in NCC Volume One J3D3 (1). Further information and resources on NatHERS are available from the [NatHERS](#) website.

An extract of Clause J3D3 (1) is shown below.

J3D3 Reducing heating and cooling loads of a sole-occupancy unit of a Class 2 building or a Class 4 part of a building using house energy rating software

- (1) The *sole-occupancy units* of a Class 2 building or a Class 4 part of a building must—
 - (a) for reducing the heating or cooling loads—
 - (i) collectively achieve an average energy rating of not less than 7 stars, including the separate heating and cooling load limits; and
 - (ii) individually achieve an energy rating of not less than 6 stars, including the separate heating and cooling load limits; and

3.1.2.3 Heating and cooling load limits

Heating and cooling load limits exist because the thermal ratings determined by NatHERS software tools are based on an SOU's total thermal energy load (i.e. the combined heating and cooling loads).

For NCC 2022, the heating and cooling load limits have been made slightly more stringent than they were in NCC 2019. Like NCC 2019, heating load and cooling load limits for NCC 2022 do not apply in NSW, NT, Tas and parts of Qld and WA.

J3D3(2) specifies that heating load and cooling load limits must be met. The limits are specified in the ABCB Standard for NatHERS heating and cooling load limits (2022) which is available from the [ABCB website](#).

3.1.2.4 Additional fabric DTS Provisions

Software tools alone cannot be used to meet certain fabric requirements that are needed for compliance with the energy efficiency Performance Requirements for an SOU. This means certain fabric requirements need to be met in addition to determining a thermal rating using a NatHERS software tool. These additional fabric requirements are listed in J2D2(2) and (3) in Volume One, as outlined in Table 3.1 below.

Table 3.1 Additional fabric DTS Provisions

DTS Provisions	Referenced DTS clauses
Thermal breaks	J3D3(1)(b), comply with J3D5 and J3D6
Compensating for a loss of ceiling insulation, other than where NatHERS software does this automatically	J3D3(1)(c), comply with Table J3D7w
General thermal construction	J3D3(1)(d), comply with J4D3
Floor edge insulation	J3D3(1)(e), comply with J3D10(3), J3D10(5) and J3D10(6)

Thermal breaks

Clause J3D5 applies to metal sheet roofing without a ceiling lining or with a ceiling lining fixed directly to metal elements. Accordingly, a thermal break greater than or equal to R0.2 is required to minimise conductive heat flow. Figure 3.2 provides an example of the thermal break requirements for roofs.

Figure 3.2 Example of roof thermal break construction

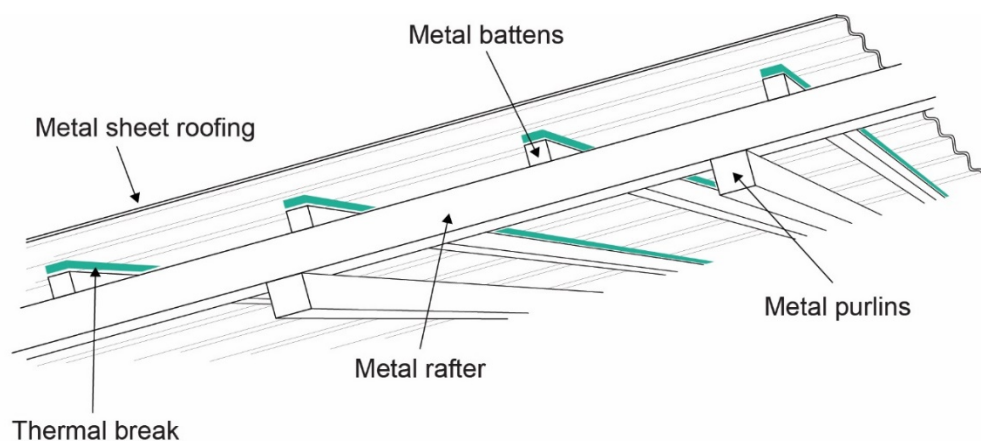

Alert

It is important to ensure that the roof or wall structure has sufficient space to accommodate the insulation without the insulation being compressed, especially in cooler climates where insulation with higher R-Values is required. Any compression of the insulation will reduce its R-Value and consequently the effectiveness of the insulation.

Sufficient space is also needed to allow an air gap below reflective vapour barrier or roof sheeting for condensation reasons.

Similarly, Clause J3D6 applies to some metal-framed wall combinations that are part of the envelope. A thermal break of at least R0.2 is required to minimise conductive heat flow. Figure 3.3 provides an example of the thermal break requirements for walls.

Figure 3.3 Example of thermal break requirement for metal-framed walls

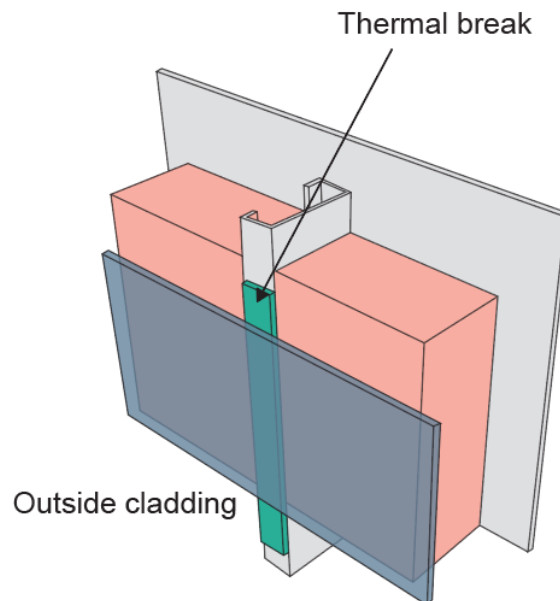

Compensation for loss of ceiling insulation

Clause J3D3(c) aims to account for loss of performance when insulation is reduced due to penetrations. To compensate, the insulation R-Value must be increased by complying with Table J3D7w of Volume One. Note that this does not apply to skylights. This requirement also does not apply when using a NatHERS accredited software tool, as it automatically compensates for a loss of ceiling insulation.



General thermal construction

Clause J3D3(1)(d) is required to comply with Clause J4D3. This clause aims to ensure that when insulation is installed:

- It performs thermally as intended
- It does not interfere with the safety or performance of plumbing or electrical components.

The general thermal construction covers integrity of the insulation, installation of reflective insulation, installation of bulk insulation, materials thermal properties and the required Total R-Value. A summary of the key requirements is in Table 3.2.

Table 3.2 Key requirements for building fabric thermal insulation

Clause J4D3	Key requirements
Integrity of the insulation	<ul style="list-style-type: none"> • Meets AS/NZS 4859.1 Materials for the thermal insulation of buildings. • Adjoins or overlaps to form a consistent and continuous thermal barrier, except at supporting members.¹⁰ • ‘Consistent and continuous’ insulation means filling any voids in the framing unless a gap is otherwise required. Voids may include between window and door jambs, surrounding lintels, and voids in intersecting walls. • Does not affect the safe or effective operation of any plumbing or electrical component.¹¹
Installation of reflective insulation	<ul style="list-style-type: none"> • Necessary airspace¹² between the reflective side of insulation and lining/cladding/ceiling insulation. • Closely fits against any penetration and adequately supported by framing. • Adjoining sheets must overlap or be taped.

¹⁰ ‘Supporting members’ include columns, studs, noggings, etc.

¹¹ This includes providing appropriate clearance as detailed in relevant legislation and referenced standards such as for electrical, gas and fuel oil installations.

¹² The width of the airspace will vary depending on the type of reflective insulation and the R-Value to be achieved.

Clause J4D3	Key requirements
Installation of bulk insulation	<ul style="list-style-type: none"> • Maintains its position and thickness, except where it crosses roof battens, water pipes, etc. • Ceiling insulation must overlap the external wall by greater than or equal to 50 mm. This only applies when there is no insulation in the external wall below.

AS/NZS 4859.1 (Materials for the thermal insulation of buildings: General criteria and technical provisions) specifies the testing criteria for insulation, including both reflective and bulk insulation. In broad terms, this standard requires the manufacturer to test its products using a specified method and then provide a data sheet. A data sheet typically explains the thermal performance and the installation requirements for the product that should be followed.

An illustration of installing bulk insulation in metal-framed walls is shown in Figure 3.4.

Figure 3.4 Installing bulk insulation in metal-framed walls

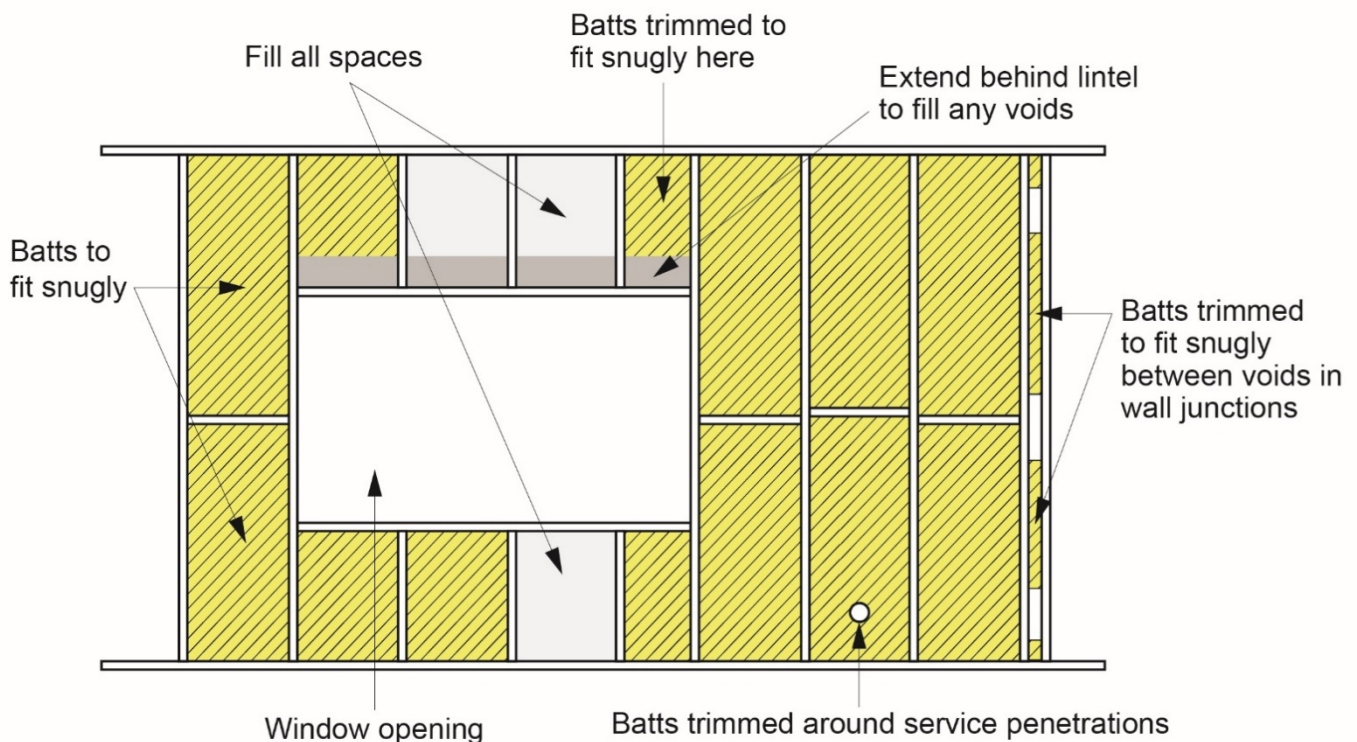

Note: Care needs to be taken when trimming bulk insulation (or ‘batts’) for installation. When installed, ensure that the batts still touch the framing and that no air gaps are evident between the framing and the batt.



Floor edge insulation

Clause J3D3(e) requires floor edge insulation to comply with J3D10(3), J3D10(5) and J3D10(6) for the NatHERS compliance option.

Table 3.3 summarises the key requirements of these subclauses.

Table 3.3 Key requirements for concrete floor edge insulation

Clause J3D10 reference	Key requirements
(1) CSOG insulation	<ul style="list-style-type: none"> • Applies to CSOG floors that have an in-slab or in-screed heating or cooling system. • Requires insulation with additional R-Value greater than or equal to R1.0 installed around the vertical edge of its perimeter.
(2) Slab insulation	<ul style="list-style-type: none"> • Applies to floors in climate zone 6 and 7: • Insulation R-Value greater than or equal to R0.64 installed around the vertical edge of its perimeter. • Insulation R-Value greater than or equal to R0.64 installed underneath the slab. • Applies to floors in climate zone 8: <ul style="list-style-type: none"> – Insulation R-Value greater than or equal to R1.0 installed around the vertical edge of its perimeter. – Insulation R-Value greater than or equal to R2.0 installed underneath the slab.
(3) Insulation installation and properties	<ul style="list-style-type: none"> • Applies to insulation required by (3). • Insulation must be installed and have the following properties: <ul style="list-style-type: none"> – Water resistant. – Continuous from the ground level to a depth greater than or equal to 300 mm. – Continuous from the ground level for at least the full depth of the vertical edge of the CSOG.



3.1.2.5 Building sealing

Part J5 Building sealing in Volume One contains the relevant DTS Provisions to adequately seal parts of a building. The intent is to restrict air infiltration and air exfiltration.¹³ Unintended leakage can lead to greater heat losses or gain and therefore reduced thermal comfort of occupants and consequently, increase the use of artificial heating and/or cooling.

Relevant clauses on building sealing are outlined in Table 3.4 and discussed in the following sections.

Table 3.4 Building sealing clauses

Building element	Clause reference
Application	J5D2
Chimneys and flues	J5D3
Roof lights	J5D4
Windows and doors	J5D5
Exhaust fans	J5D6
Construction of ceilings, walls and floors	J5D7
Evaporative coolers	J5D8

Application of Part

Clause J5D2 specifies the DTS Provisions for building sealing apply to the elements forming the envelope of a Class 2 to 9 building.

There are 3 exemptions.

- (1) A building in climate zones 1, 2, 3 and 5 where the only means of air-conditioning is by using an evaporative cooler.
- (2) A permanent building opening, in a space where a gas appliance is located, that is necessary for the safe operation of a gas appliance.
- (3) A building or space where the mechanical ventilation required by Part F6 provides sufficient pressurisation to prevent infiltration.

¹³ See the terms 'air infiltration and 'air exfiltration' in the Glossary at Appendix B for more information.

**Alert**

Appropriate ventilation requirements for gas appliances can be obtained from relevant state and territory legislation, referenced standards and product installation manuals.

Chimneys and flues

Clause J5D3 requires a solid-fuel burning appliance (e.g. wood fireplace) to have a damper or flap on its chimney or flue so that it can be closed. The intent of this requirement is to prevent conditioned air being drawn up the chimney or flue when the appliance is not in use.

Roof lights

Clause J5D4 provides the minimum sealing requirements for roof lights (skylights). The skylight sealing requirements consist of 2 subclauses. The key requirements of these subclauses are summarised in Table 3.5.

Table 3.5 Key requirements to seal skylights

Clause J5D4 reference	Key requirements
(1) Application	<ul style="list-style-type: none"> Skylights must be sealed, or capable of being sealed in either of the following locations: <ul style="list-style-type: none"> a conditioned space, or a habitable room in climate zones 4, 5, 6, 7 and 8.
(2) Sealing requirements	<ul style="list-style-type: none"> Sealing can be achieved by any of the following: <ul style="list-style-type: none"> A ceiling diffuser (no holes). A weatherproof seal. A manual, mechanical or electronic shutter system.

Windows and doors

Clause J5D5 provides the minimum sealing requirements for windows and doors. The requirements consist of 2 subclauses. The key requirements are summarised in Table 3.6.

Table 3.6 Key requirements to seal windows and doors

Clause J5D5 reference	Key requirements
(1) Application	<ul style="list-style-type: none"> Applies to the following doors, openable windows and similar openings when: <ul style="list-style-type: none"> when they form part of the envelope, or



Clause J5D5 reference	Key requirements
	<ul style="list-style-type: none"> – are in climate zones 4, 5, 6, 7 or 8.
(2) Sealing requirements	<ul style="list-style-type: none"> • A draft protection device must be used to seal the bottom edge of a door. • A foam or rubber compressible strip, or fibrous seal, must be used to seal the other edge of doors and openable windows.
(3) Exemption	<ul style="list-style-type: none"> • Windows that comply with AS 2047. • Fire doors or smoke doors. • Roller shutter doors, roller shutter grille or other security doors or devices.

Exhaust fans

Clause J5D6 sets out the requirements to self-exhaust fans.

Exhaust fans must be sealed with a self-closing damper or filter when located in one of the following:

- A conditioned space.
- A habitable room in climate zones 4, 5, 6, 7 or 8.

Construction of ceilings, walls and floors

Clause J5D7 provides the minimum requirements for sealing ceilings, walls and floors at junctions and around window and door penetrations.

The requirements consist of 2 subclauses. A summary of the key requirements is outlined in Table 3.7.

Table 3.7 Key construction requirements to seal ceilings, walls and floors

Clause J5D7 reference	Key requirements
(1) Application	<ul style="list-style-type: none"> • Applies to the construction of ceilings, floors, window frames, door frames, skylight frames and the like to minimise air leakage when: <ul style="list-style-type: none"> – forming part of the building envelope, or – located in climate zones 4, 5, 6, 7 or 8.



Clause J5D7 reference	Key requirements
(2) Construction requirements	<ul style="list-style-type: none">• Option 1: Construction in (1) must be enclosed by internal lining systems that are close-fitting for the following construction elements:<ul style="list-style-type: none">– ceilings– walls and floor junctions.• Option 2: Construction in (1) must be sealed at junctions and penetrations by either of the following:<ul style="list-style-type: none">– close-fitting architraves, skirting or cornices– expanding foam, rubber compressive strip or caulking.
(3) Exemption	<ul style="list-style-type: none">• Openings, grilles or the like required for smoke hazard management.

Evaporative coolers

Clause J5D8 provides the minimum requirements to seal evaporative coolers. Evaporative coolers must be sealed with a self-closing damper when serving a heated space, or located in climate zone 4, 5, 6, 7 or 8.

3.1.2.6 WOH rating

J3D15 requires a WOH rating not less than 50 (out of 100) is achieved using NatHERS software. A WOH rating includes the fuel type and efficiency of heating and heated water systems, the efficiency of cooling systems, an allowance for lighting and the efficiency and energy use of pools and spas. This reflects the scope and level of stringency specified in Performance Requirement J1P3.

More information on WOH ratings, including NatHERS certificates, is available from the [NatHERS website](#) and section 3.1.3 of this document which contains useful tips.

Alert

The WOH rating J3D15 and the DTS Provisions for Services in Part J6 and J7 contain requirements for an apartment's domestic services, and both parts need to be met. This should be considered during the selection of the domestic services, including the size of any on-site renewable energy such as rooftop solar PV and the heated water service.

**Alert**

Centralised hot water systems in Class 2 apartment buildings do not have a DTS pathway in NCC 2022. A Performance Solution, such as J1V5 Verification using a reference building for a Class 2 sole-occupancy unit, must be developed for a proposed Class 2 building with a centralised hot water system.

3.1.2.7 Air-conditioning and ventilation

Part J6 sets out the provisions for the efficiency and control of air-conditioning and ventilation.

This includes air-conditioning, space heating and ventilation equipment, the efficiency, sealing and insulation requirements for ductwork systems containing fans, and for the efficiency and insulation of pipework and pump systems. Note that there may be instances where clauses in Part J6 will not apply within an SOU because the equipment being covered will not be present within the SOU itself.

The relevant J6 clauses for different services are outlined in Table 3.8.

Table 3.8 Air-conditioning and ventilation clauses

Service	Clause reference
Application	J6D2
Air-conditioning system control	J6D3
Mechanical ventilation system control	J6D4
Fans and duct systems	J6D5
Ductwork insulation	J6D6
Ductwork sealings	J6D7
Pump systems	J6D8
Pipework insulation	J6D9
Space heating	J6D10
Unitary air-conditioning equipment	J6D12

Note to Table 3.8: These clauses generally apply to an apartment building except for some clauses where they do not apply if there is only one SOU.

Application

The DTS Provisions for air-conditioning and ventilation specified in Part J6 cover several building classifications including an SOU in an apartment building.



Air-conditioning system control

The requirements for air-conditioning system control are summarised in Clause J6D3. The requirements relevant to an SOU are outlined in Table 3.9. Clause J6D3(f) is not relevant to an SOU.

Table 3.9 Key requirements for air-conditioning system control

J6D3 reference	Key requirements
(1) An air-conditioning system	<ul style="list-style-type: none">• Must be capable of being deactivated when the building or part of that building served by that system is not occupied.• When serving more than one air-conditioning zone or area with different heating or cooling needs, must:<ul style="list-style-type: none">– thermostatically control the temperature of each zone or area– not control the temperature by mixing actively heated/cooled air– limit reheating to not more than a 7.5K rise in temperature at a fixed supply air rate as well as at the nominal supply air rate for a variable supply air rate.• Possess an outdoor air economy cycle function according to Table J6D3.• Capable of stopping the flow of water to those not operating.• With an airflow of more than 1000 L/s, must have a variable speed fan when its supply air quantity is capable of being varied.• Use direct signals to regulate the operation of central plant.• A control dead band of not less than 2°C in general.• Provided with balancing dampers and balancing valves to ensure achieving the maximum design air/fluid flow, but not exceeded by more than 15% for each component or group of components.• Automatic variable temperature operation of heated water and chilled water circuits.• Close any motorised outdoor air or return air damper that is not otherwise being actively controlled.



J6D3 reference	Key requirements
(2) Two or more air-conditioning systems	<ul style="list-style-type: none"> Control sequences must be used when two or more air-conditioning systems serve the same space.
(3) Time switches	<ul style="list-style-type: none"> Time switches must be provided as follows. <ul style="list-style-type: none"> When controlling an air-conditioning system of more than 2 kW_r and a heater of more than 1 kW_{heating}. Be capable of switching electric power on and off at variable pre-programmed times and on variable pre-programmed days. The above requirements do not apply to: <ul style="list-style-type: none"> an air-conditioning system that serves only one SOU in an apartment building a conditioned space where air-conditioning is needed for 24 hour continuous use.

Mechanical ventilation system control

Clause J6D4 specifies the requirements for a mechanical ventilation system control, which are outlined in Table 3.10.

Table 3.10

Table 3.10 Key requirements for mechanical ventilation systems

J6D4 reference	Key requirements
(1) General	<ul style="list-style-type: none"> Specifies requirements for mechanical ventilation system control, except for systems which serve a single SOU in an apartment building or a Class 4 part of a building. Be capable of being deactivated when the building or part of the building it serves is unoccupied. When serving a conditioned space, except when an evaporative cooler is in use: <ul style="list-style-type: none"> Have energy reclaiming systems for systems specified in J6D4 Demand control ventilation as per AS 1668.2 for systems specified in J6D4.



	<ul style="list-style-type: none">• Not exceed minimum outdoor air requirements of F6 except:<ul style="list-style-type: none">– Free cooling of the system is supplied by additional unconditioned outdoor air– The required exhaust or process exhaust needs additional mechanical ventilation– Outdoor air is preconditioned by an energy reclaiming system.• Have a variable speed fan for systems with an airflow of 1000 L/s or more, except if downstream airflow is required by Part F6
(2) Exhaust systems	<ul style="list-style-type: none">• Not applicable to exhaust systems in an SOU of a Class 2 building
(3) Carpark exhaust systems	<ul style="list-style-type: none">• Not applicable to exhaust systems in an SOU of a Class 2 building
(4) Time switches	<ul style="list-style-type: none">• Be provided to mechanical ventilation systems with an air flow for 100 L/s or more• Be capable of switching electric power on or off at variable pre-programmed times and on variable pre-programmed days• Exemptions:<ul style="list-style-type: none">– Mechanical ventilation system that serves a single SOU in a Class 2 building– Where mechanical ventilation is needed for 24-hour occupation.

Fans and duct systems

Clause J6D5 sets out requirements for fans, ductwork and duct components used as part of an air-conditioning system or mechanical ventilation system. The key requirements for J6D5 are in Table 3.11. Note that there may be instances where clauses in Part J6 will not apply within an SOU because the equipment being covered will not be present within the SOU itself. For example, some SOUs may not have a standalone ducted heating, ventilation and cooling (HVAC) system.



Table 3.11 Key requirements for fan and duct systems

J6D5 reference	Key requirements
(1) Application	<ul style="list-style-type: none">Fans, ductwork and ducts in an air-conditioning or mechanical ventilation system must:<ul style="list-style-type: none">Option 1 - separately comply with the requirements for fans, ductwork and ductsOption 2 – achieve a fan motor input power per unit of flowrate lower than the fan motor input power per unit of flowrate of (2) to (5) combined.
(2) Fans	<ul style="list-style-type: none">Fans must have a minimum efficiency at full load calculated as outlined in J6D5(2).J6D5(2) has separate calculation methods for systems with static pressure of 200 Pa or less, and above 200 Pa.
(3) Ductwork	<ul style="list-style-type: none">Pressure drop in the index run must not exceed 1 pa/m¹⁴Flexible ductwork must not be more than 6m in any duct runBends, elbows and tees must have an equivalent diameter to the duct they are connected toTurning vanes to be included in all rigid ductwork elbows of 90° or less except:<ul style="list-style-type: none">when their inclusion presents a fouling riskwhen a long radius bend, in accordance with AS 4254.2 Ductwork for air-handling systems in buildings – Rigid duct, is used.

¹⁴ Averaged over the entire length of duct. The pressure drop of flexible ductwork sections may be calculated as if flexible ductwork is laid straight.



J6D5 reference	Key requirements
(4) Ductwork components	<ul style="list-style-type: none">• Set outs requirements for ductwork components in the index run and cover the following:<ul style="list-style-type: none">– pressure drop across coils– high efficiency particulate arrestance (HEPA) air filters– other air filters– intake louvres– variable air volume boxes– rooftop cowls– attenuators– fire dampers– balancing and control dampers– supply air diffusers– exhaust grilles– transfer ducts– door grilles– active chilled beams.
(5) Exemptions	<ul style="list-style-type: none">• The requirements of (1) to (4) don't apply to:<ul style="list-style-type: none">– fans in unducted air-conditioning systems with a capacity of less than 1000 L/s– smoke spill fans– the power for process-related components– kitchen exhausts

Note to Table 3.11: Application of J6D5 (1) to (4) to an SOU in a Class 2 building is dependent on the design of the air-conditioning system.

Ductwork insulation

J6D6 sets out the requirements for insulating ductwork and fittings in an air-conditioning system. The key requirements for J6D6 can be found in Table 3.12.



Table 3.12 Key requirements for ductwork insulation

J6D6 reference	Key requirement
(1) Application	<ul style="list-style-type: none">• Specifies that insulation for ductwork and fittings for air-conditioning systems must:<ul style="list-style-type: none">– comply with AS 4859.1 Thermal insulation materials for building – General criteria and technical provisions– have a minimum insulation R-Value of:<ul style="list-style-type: none">○ R1.0 for flexible ductwork, or○ for cushion boxes equivalent to connecting ductwork, or○ comply with Table J6D6.
(2) Installation of ductwork insulation	<ul style="list-style-type: none">• Insulation must:<ul style="list-style-type: none">– be protected from the weather– abut adjacent insulation to form continuous layer– maintain its thickness other than at flanges or supports– be protected by a vapor barrier on the outside of the insulation when conveying cool air. The vapour barrier must be installed so adjacent layers overlap by 50mm and bonded or taped together
(3) Exemptions	<ul style="list-style-type: none">• The requirements of (1) do not apply to:<ul style="list-style-type: none">– ductwork and fittings located in the only or last room served by the system– fittings that form part of the interface with the conditioned space– return air ductwork which are in, or passing through a conditioned space– ductwork for outdoor air and exhaust air associated with an air-conditioning system.– the floor of an in-situ air-handling unit– packaged air conditioners, split systems and variable refrigerant flow air-conditioning equipment complying with Minimum Energy Performance Standards (MEPS)– flexible fan connectors.
(4) Fittings	<ul style="list-style-type: none">• Include non-active components of a ductwork system such as cushion boxes.• Exclude active components such as air-handling unit components.



Ductwork sealing

J6D7 specifies the sealing of ductwork for large air-conditioning systems (capacity of 3000 L/S or greater). It specifies ductwork that is not located within the only or last room served by the system must be sealed from loss in accordance with AS 4254.1 and AS 4254.2

Pump systems

J6D8 set out the minimum requirements for pumps which form part of an air-conditioning system. Table 3.13 summarises the key requirements of J6D8.

Table 3.13 Summary of key requirements for pumps

J6D8 reference	Key requirements
(1) Application	<ul style="list-style-type: none"> Pumps and pipework which form part of an air-conditioning system must: <ul style="list-style-type: none"> separately comply with J6D8 (2) to (4) achieve a pump motor power per unit of flow rate lower than the pump motor power per unit of flowrate achieved when applying the provisions of J6D8.
(2) Circulator pumps	<ul style="list-style-type: none"> Glandless impeller pump with a rated output of less than 2.5 kW and used in closed loop systems Energy efficiency Index (EEI) less than 0.27 EEI must be calculated in accordance with European Union Commission Regulation No. 622/2012.
(3) Other pumps	<ul style="list-style-type: none"> Other pumps must be in accordance with European Union Commission No. 547/2012 articles No. 1 and 2. EEI of at least 0.4. EEI must be calculated in accordance with European Union Commission Regulation No. 622/2012
(4) Pipework	<ul style="list-style-type: none"> Applies to straight sections of pipework along the index run that form part of the air-conditioning system. For pipework systems that do not have any branches and have the same flow rate through the entire network, an average pressure drop less than the value specified in Table J8D8a or J8D8b. For any other pipework system, an average pressure drop less than the value specified in Table J8D8c or J8D8d.



J6D8 reference	Key requirements
(5) Exemptions	<ul style="list-style-type: none"> (4) does not apply to: <ul style="list-style-type: none"> valves and fittings pipework, where the smallest pipe size compliant with (4) results in a velocity of less than 0.7 m/s design flow.

Pipework insulation

J6D9 specifies the DTS requirements for pipework insulation for piping, vessels and tanks which contain heating or cooling fluids. Table 3.14 provides a summary of the key requirements for J6D9.

Table 3.14 Summary of requirements for pipework insulation

J6D9	Key requirements
(1) Application	<ul style="list-style-type: none"> Requires insulation for piping, vessels, heat exchangers and tanks containing heating and cooling fluid held at a heated or cooled temperature. Insulation must: <ul style="list-style-type: none"> comply with AS4859.1 for piping used heating and cooling, have an R-Value in accordance with Table J6D9a for vessels, heat exchangers or tanks, have insulation in accordance with Table J6D9b for refill or pressure relief piping, have insulation with an R-Value equal to the required insulation value of the connected pipe, vessel or tank within 500 mm of the connection. An exemption applies for piping, vessels and tanks that contain heating or cooling fluids in appliances covered by Minimum Energy Performance Standards (MEPS).
(2) Insulation installation	<ul style="list-style-type: none"> Insulation must be: <ul style="list-style-type: none"> protected against the effects of weather and sunlight able to withstand the temperatures within the piping, vessel, heat exchanger or tank.
(3) Vapour barrier protection	<ul style="list-style-type: none"> Vapour barriers are required to be installed on the outside of insulation provided for piping, vessels, heat exchangers or tanks



(4) Exemptions	<ul style="list-style-type: none"> • The requirements of (1) and (2) do not apply to piping, vessels or heat exchangers: <ul style="list-style-type: none"> – located in the only or last room served by the system and downstream of the control device for the regulation of heating or cooling service to that room – encased within concrete slab or panel which is part of a heating or cooling system – supplied as an integral part of a chiller, boiler or unitary air-conditioner complying with the requirements of J6D 10 to J6D12 – inside an air-handling unit, fan-coil unit or similar.
(5) Definitions	<ul style="list-style-type: none"> • For the purposes of (1) to (4): <ul style="list-style-type: none"> – heating fluids include refrigerant, heated water, steam and condensate – cooling fluids include refrigerant, chilled water, brines and glycol mixtures but do not include condenser cooling water.

Alert

AS 4859.1 specifies requirements and methods of testing of materials that are used in opaque envelopes of buildings and building services to provide thermal insulation. This includes ductwork and pipework. The DTS Provisions are based on AS 4859.1 calculation methods.

Space heating

The minimum requirements for space heating can be found in J6D10. Table 3.15 summarises the key requirements for J6D10.

Table 3.15 Summary of requirements for space heating

J6D10 reference	Key requirements
(1) Heaters	<ul style="list-style-type: none"> • Specifies that heaters used for air-conditioning must be one of the following: <ul style="list-style-type: none"> – a solar heater – a gas heater – a heat pump heater – a heater which reclaims heat from another process



	<ul style="list-style-type: none">– an electric heater– any combination of the above.• An electric heater must have the following properties:<ul style="list-style-type: none">– a heating capacity of 10 W/m² for climate zone 1– a heating capacity of 10 W/m² for climate zone 2– a heating capacity as specified in Table J6D10 where reticulated gas is not available to the allotment boundary– an annual energy consumption of 15 kWh/m² or less for climate zones 1 to 5– an in-duct heater must comply with J6D3(1)(b)(iii)
(2) Bathroom heating	<ul style="list-style-type: none">• Bathrooms in an apartment building can be heated with an electric heater with a capacity of 1.2 kW or less.
(3) Outdoor spaces	<ul style="list-style-type: none">• Where a fixed heating or cooling appliance moderates the temperature of an outdoor space, it must be able to automatically shutdown when:<ul style="list-style-type: none">– there are no occupants– it has been running for an hour– the space has reached the designed temperature.
(4) Gas water heater	<ul style="list-style-type: none">• Where a gas water heater is used as part of an air-conditioning system for space heating (not for sanitary purposes) it must:<ul style="list-style-type: none">– achieve a minimum gross thermal efficiency of 86%, if rated to consume 500 MJ/hour of gas or less– achieve a minimum gross thermal efficiency of 90% if rated to consume more than 500 MJ/hour of gas.

Unitary air-conditioning equipment

J6D12 specifies the minimum requirements for unitary air-conditioning equipment. Table 3.16 provides a summary of the key requirements of J6D12.



Table 3.16 Summary of unitary air-conditioning equipment

J6D12(1) reference	Key requirement
(a) Cooled water	<ul style="list-style-type: none"> Air-conditioning equipment must have a minimum energy efficiency ratio of $4.0 W_r/W_{input\ power}$ for cooling in accordance with AS/NZS 3823.1.2¹⁵, at test condition T1.
(b) Cooled air	<ul style="list-style-type: none"> Air-conditioning equipment must have a minimum energy efficiency of $2.9 W_r/W_{input\ power}$ cooling in accordance with AS/NZS 3823.1.2 at test condition T1

3.1.2.8 Artificial lighting and power

Part J7 aims to limit unreasonable energy use from artificial lighting and power. The requirements only apply to artificial lights that are permanently installed.

To produce the same light output, different lighting systems use different amounts of energy. The NCC requirements recognise lighting systems that use technology such as timers or dimmers to reduce energy consumption.

Apart from clause numbering, the DTS Provisions for artificial lighting and power are unchanged for NCC 2022 when compared to NCC 2019.

A summary of the relevant clauses on artificial lighting and power that apply to an SOU of an apartment building is outlined in Table 3.17.

Table 3.17 Artificial lighting and power clauses

Artificial lighting and power	Clause reference
Application	J7D2
Artificial lighting	J7D3
Interior artificial lighting and power control	J7D4
Interior decorative and display lighting	J7D5
Exterior artificial lighting	J7D6

To assist in determining compliance, a Lighting Calculator is available from the Resource Library on the [ABCBC website](#).

¹⁵ AS/NZS 3823.1.2 Performance of electrical appliances – Air conditioners and heat pumps – Ducted air conditioners and air-to-air heat pumps – Testing and rating for performance.



Application

Part J7 sets out the application of the requirements for artificial lighting and power. While it applies to an SOU in an apartment building, it also applies to several other building classifications.

Artificial lighting

A summary of the key artificial lighting requirements for an SOU is provided in Table 3.18.

Table 3.18 Key requirements for artificial lighting in an SOU

J7D3 subclause reference	Key requirements
(1) Allowances for an SOU in a Class 2 building	<ul style="list-style-type: none"> • Lamp power density or illumination power density allowances: <ul style="list-style-type: none"> – less than or equal to 5 W/m² in an SOU – less than or equal to 4 W/m² on a verandah or balcony or like attached to a SOU. • The illumination power density allowance can be increased by applying illumination power density adjustment factors (Table J7D3b). • The power of the proposed installation must be used rather than nominal allowances of complete light fittings. • Halogen lights must be separately switched from fluorescent lights, as halogen lights consume more energy.
(3) Exemptions	<ul style="list-style-type: none"> • The requirements of (1) do not apply to the following: <ul style="list-style-type: none"> – emergency lighting provided in accordance with Part E4 – a heater where the heater also emits light, such as in bathrooms – lighting installed solely to provide photosynthetically active radiation for indoor plant growth on green walls and the like.
(4) Additional requirements	<ul style="list-style-type: none"> • Following Table J7D3b, the following control devices must comply with Specification 40: <ul style="list-style-type: none"> – lighting timers – motion detectors – daylight sensors and dynamic lighting control devices.

In addition to the requirements of J7D3, J7D4 and J7D5 contain requirements for an SOU in an apartment building. Not all clauses in J7D4 and J7D5 apply to SOUs.



A summary of the applicable clauses from J7D4 and J7D5 is in Table 3.19.

Table 3.19 Summary of key requirements from J7D4 and J7D5

Clause reference	Key requirement
J7D4 (1)	<ul style="list-style-type: none"> Artificial lighting in a room or space must be individually controlled by a switch, other control device, or combination of these two.
J7D4 (3) (a)	<ul style="list-style-type: none"> Artificial lighting switches must be located: <ul style="list-style-type: none"> in visible and easily accessed locations in the room or space being switched or in an adjacent room or space, where 90% of the lighting being controlled is visible.

Exterior artificial lighting

Clause J7D6 requirements cover external lighting attached to or directed at the façade of a building. A summary of clauses in J7D6 is in Table 3.20.

Table 3.20 Key requirements for exterior artificial lighting

J7D6 reference	Key requirement
(1) Exterior lighting	<ul style="list-style-type: none"> Provides controls for exterior lighting directed or attached the façade of a building Must be controlled by day light sensors or time switches Options for when total lighting load exceeds 100 W: <ul style="list-style-type: none"> Option 1 - Use LED luminaires for 90% of the total lighting load Use motion detectors in accordance with Specification 40 Have a separate time switch in accordance with Specification 40 when used for decorative purposes.
(2) Exemption	<ul style="list-style-type: none"> (1)(b) does not apply to emergency lighting in accordance with Part E4.

3.1.3 Useful tips

3.1.3.1 Thermal ratings and WOH ratings

- Thermal ratings and WOH ratings are conducted by a NatHERS assessor. Check with your local certifying authority on what accreditations they require of an assessor.



- The WOH requirements for an SOU are different to those for houses. This is because people living in an SOU usually face greater constraints on installing solar panels to offset their energy costs than people living in detached houses.
- To assist compliance with the thermal rating and WOH rating requirements, NatHERS have developed a range of education and support materials. These are available from the [NatHERS website](#).
- Further information and resources will continue to be developed and released by the NatHERS Administrator, software tool providers and Assessor Accrediting Organisations (AAOs).
- The calculations used in NatHERS software tools are based on scientific research by the CSIRO.

Reminder

The NatHERS compliance option now includes 2 ratings: a thermal rating and a WOH rating. A thermal rating assesses the thermal performance (heating and cooling loads) of a proposed SOU. The results are converted to a score between 0 and 10 stars. A WOH rating is more holistic and assesses equipment efficiencies and any offsets from on-site renewable energy of a proposed SOU.

The WOH rating takes into account the thermal performance of the envelope when determining a score out of 100. Higher performing envelopes should lead to a higher WOH score. This score provides the compliance pathway to Performance Requirement J1P3. Therefore, the WOH score does not indicate compliance for the thermal envelope Performance Requirement (J1P2). This must be demonstrated separately.

3.1.3.2 Heating and cooling load limits

- The heating and cooling load limits are specified in the ABCB Standard for NatHERS Heating and Cooling Load Limits (2022), which is available from the [ABCBC website](#).

3.1.3.3 Additional fabric DTS Provisions

- In addition to a thermal rating, the selection and installation of reflective and bulk insulation must meet other requirements for an SOU in NCC Volume One.
- Requirements on the installation of bulk insulation in residential dwellings is provided by AS 3999: Bulk thermal insulation – Installation.
- The effects of thermal bridging are accounted for in NatHERS software. However, there are additionally requirements for thermal bridging - being J3D5 and J3D6. This means you must show compliance with both the NatHERS rating and the abovementioned J3 clauses.



- Despite NatHERS software accounting for thermal bridging, the thermal break requirements of subclauses J3D5 and J3D6 as well as J4D3 of NCC Volume One still need to be met, where applicable.
- Reflective insulation alone is not suitable for use as a thermal break since it requires an adjoining airspace to achieve its specified R-Value.

3.1.3.4 Building sealing

- Air leakage most commonly occurs at the:
 - roof/ceiling to wall junction
 - floor to wall junction
 - wall to door frame junction
 - wall to window frame junction
 - all services penetrations.
- For exhaust fans, a simple flap damper system can fulfil the minimum requirements. These are readily available for most fan types.
- In addition to the sealing requirements for chimneys and flues, Part G2 of NCC Volume One also contains requirements that need to be met.
- The term, 'close-fitting' is used in subclause J5D7(2), Construction of ceilings, walls and floors. What does this term mean? Since doors and windows require a compressible seal, it would not be acceptable to have visible gaps surrounding the window or door unit. Therefore, a reasonable interpretation of 'close fitting' could be a gap less than that between the compressible seal of a closed window or door and the associated frame.

3.1.3.5 Assessment Methods for DTS Solutions

The DTS Provisions that form the NatHERS compliance option are used to demonstrate NCC compliance using a DTS Solution. An overview of how to comply with the NCC is in Appendix C of this document. A2G3(2) sets out the following Assessment Methods as being suitable for demonstrating compliance for DTS Solutions.

- Evidence of suitability (NCC Clauses A2G2, A2G3, A5G1 to A5G4).
- Expert Judgement (NCC Clauses A2G2 and A2G3).
- Due to the nature of NatHERS software, evidence of suitability is the appropriate Assessment Method when using NatHERS to demonstrate the compliance of a DTS Solution. This is outlined in the following sections.



3.1.3.6 Evidence of suitability

Evidence of suitability, also known as 'documentary evidence', can generally be used to support that a material, product, form of construction or design satisfies a DTS Provision. Subject to certain NCC provisions, the form of evidence that may be used consists of one, or a combination, of the following.

- A report from an Accredited Testing Laboratory.
- A Certificate of Conformity or a Certificate of Accreditation.
- A certificate from a professional engineer or appropriately qualified person.
- A current certificate issued by a product certification body that has been accredited by the Joint Accreditation System of Australia and New Zealand (JAS-ANZ).
- Any other form of documentary evidence that adequately demonstrates suitability such as a Product Technical Statement.

More information on this Assessment Method is available in the ABCB Evidence of Suitability Handbook which is available from the [ABCB website](#).

In relation to residential energy efficiency, individual jurisdictions may have issued directions or notices specifying what documentary evidence is considered acceptable to demonstrate compliance.

The NCC contains limitations on the application and use of evidence of suitability in certain circumstances. One of those circumstances is where compliance with the NCC energy efficiency Performance Requirements for an SOU in an apartment building is demonstrated using NatHERS. See 3.1.4.3 below.

3.1.3.7 NatHERS certificate

Compared to NCC 2019, NCC 2022 requires specific documentary evidence when the NatHERS DTS compliance option is used. See NCC Clause A5G9. The evidence of suitability must be in the form of a NatHERS certificate issued in accordance with NatHERS. NatHERS has developed further guidance on NatHERS Certificates which is available from the [NatHERS website](#).

3.1.4 Examples

- To assist with understanding of the thermal rating requirement, the NatHERS Administrator has developed worked examples. These are available from the [NatHERS website](#).
- An example of compliance with the heating and cooling load limit requirements of Clause J3D3 is provided in [Appendix D.1](#).
- To assist complying with the artificial lighting requirements, an example is provided in [Appendix D.6](#).



3.2 Compliance Option 2: Elemental

3.2.1 Introduction

The Elemental compliance option is a set of DTS Provisions that can be used to meet the energy efficiency Performance Requirements for an SOU of an apartment building, i.e., J1P2 and J1P3.

The DTS Provisions that form the Elemental compliance option are used to demonstrate NCC compliance using a DTS Solution. See Appendix C for more information on how to comply with the NCC.

This compliance option is in the DTS Provisions of NCC Volume One clauses J2D2(2)(b), J2D2(3)(a)(i) and J2D2(3)(b) and (c). Compared to NCC 2019, this is a new compliance option for NCC 2022.

Alert

Figure 2.1 and Table 2.3 in Chapter 2 provide a simplified overview of compliance options, noting a combination of DTS Solutions is permitted. For example NatHERS could be used to meet J1P2 and the Elemental provisions used to meet J1P3 or visa versa.

3.2.2 Method

The intent of this method is to provide a step-by-step approach to comply with the relevant energy efficiency Performance Requirements. To do this, the method requires each element to meet a minimum level of thermal performance or efficiency, for example, floors, walls, glazing, roofs and ceilings.

These requirements are specified in the DTS Provisions and when followed in their entirety form a DTS Solution that meets the energy efficiency Performance Requirements that apply to an SOU.

Figure 3.5 outlines the relevant DTS Provisions that form the Elemental compliance option. These are located in Parts J2 to J7 of NCC Volume One.

Figure 3.5 Elemental DTS compliance option for an SOU

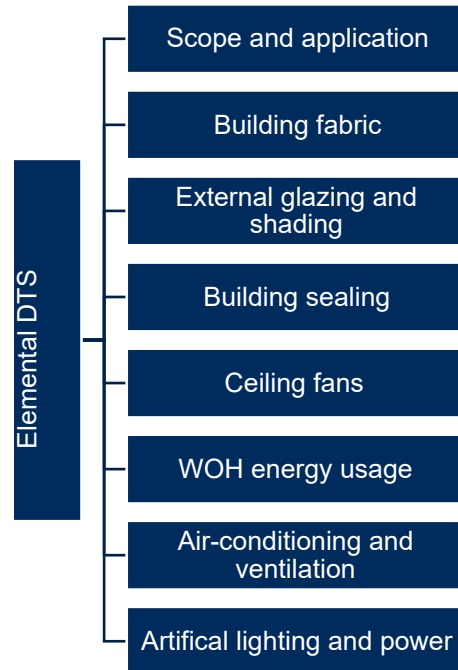

3.2.2.1 Scope and application

Clauses J2D2(2)(b) and J2D2(3)(a)(i), (b) and (c) specify the scope and application of the elemental provisions to an SOU of an apartment building.

To achieve the intended outcome, the DTS Provisions must be applied in accordance with the Governing Requirements and any state and territory variations, additions and deletions.

3.2.2.2 Building fabric

Parts J3 and J4 (Building fabric) contains the relevant elemental provisions for the minimum thermal performance of the opaque part of the envelope of an SOU (i.e., walls, floor and roof). These are outlined in Table 3.21 and discussed in the following sections.

Table 3.21 Building fabric clauses

Building element	Clause reference
Application	J3D2, J4D2
Thermal construction	J4D3(1) to (4)
Thermal breaks	J3D5, J3D6
Roofs and ceilings	J3D7
External walls	J3D8
Floors	J3D10



Application

The application of the building fabric requirements is split across J3D2 and J4D2.

J3D2 specifies the elemental provisions for building elements that form the external fabric (i.e. walls, floors and roofs) of an SOU of an apartment building or a Class 4 part of a building.

J4D2 states that various clauses in Part J4 do not apply to an SOU of an apartment building or Class 4 part of a building. In doing so, Clause J4D2 specifies that Clauses J4D3(1) to (4) **do apply** to the building elements of an SOU that form part of the envelope of an apartment building. These clauses are concerned with the thermal construction of the building fabric and are discussed below.

Thermal construction

Clauses J4D3(1) to (4) contain the general provisions for thermal construction. These requirement aims to ensure that when insulation, either bulk or reflective is installed, it:

- thermally performs as intended, and
- does not interfere with the safety or performance of plumbing or electrical components.

A summary of the key requirements of these subclauses is in Table 3.22.

Table 3.22 Key requirements for J4D3 thermal construction

Clause J4D3 reference	Key requirements
(1) Integrity of the insulation	<ul style="list-style-type: none"> • Meets AS/NZS 4859.1 Materials for the thermal insulation of buildings • Adjoins or overlaps to form a consistent and continuous thermal barrier, except at supporting studs and noggins etc • ‘Consistent and continuous’ insulation means filling any voids in the framing unless a gap is otherwise required. Voids may include between window and door jambs, surrounding lintels, and voids in intersecting walls. • Does not affect the safe or effective operation of any plumbing or electrical component
(2) Installation of reflective insulation	<ul style="list-style-type: none"> • Necessary airspace¹⁶ between the reflective side of insulation and lining/cladding insulation • Closely fits against any penetration and adequately supported by framing

¹⁶ The width of the airspace will vary depending on the type of reflective insulation and the R-Value to be achieved.



Clause J4D3 reference	Key requirements
	<ul style="list-style-type: none"> Installed so there is no air leakage across the reflective insulation Adjoining sheets must overlap by 50mm or be taped
(3) Installation of bulk insulation	<ul style="list-style-type: none"> Maintains its position and thickness, except where it crosses roof battens, water pipes etc Ceiling insulation must overlap the external wall by greater than or equal to 50 mm. This only applies when there is no insulation in the external wall below.
(4) Roof, ceiling, wall and floor materials	<ul style="list-style-type: none"> Deems materials used for roofs, ceilings, walls and floors to have the thermal properties as specified in Specification 36 (see Table 3.23 for a summary of Specification 36)

Table 3.23 Summary of Specification 36

Specification 36 reference	
S36C1 Scope	<ul style="list-style-type: none"> Outlines that specification 36 provides thermal properties for some common construction materials
S36C2 (1) Thermal conductivity	<ul style="list-style-type: none"> Tables S36C2a to S36C2e provide thermal conductivity properties for some common construction materials
S36C2 (2) R-Value	<ul style="list-style-type: none"> Outlines that values in Tables S36C2a to S36C2e are based on gross densities (mass divided by external dimensions). That R-Value of a material can be determined by dividing the thickness of the material by its thermal conductivity
S36C2 (3) Air films and air spaces	<ul style="list-style-type: none"> Provides R-Values considered to be achieved by air films and air spaces in Table S36C2f to Table S36C2m
S36C2 (4) Ventilation openings	<ul style="list-style-type: none"> Specifies that where an envelope contains a ventilated airspace, the Total R-Value must be reduced based on the area of ventilation opening AS/NZS 4859.2 Thermal insulation materials for buildings - Design clause 6.3 is to be used to determine this reduction in Total R-Value
S36C2 (5) exemption	<ul style="list-style-type: none"> Requirements of (4) do not apply to roofs with an airspace greater than 300mm, or a roof pitch of greater than 5° with a horizontal ceiling

AS/NZS 4859.1 specifies the testing criteria for insulation, including both reflective and bulk insulation. In broad terms, this standard requires the manufacturer test its products using a specified method and then provide a data sheet. A data sheet typically explains the thermal performance and the installation requirements for the product that should be followed.

See Figure 3.6 for an illustration of installing bulk insulation in walls.

Figure 3.6 Installing bulk insulation in framed walls

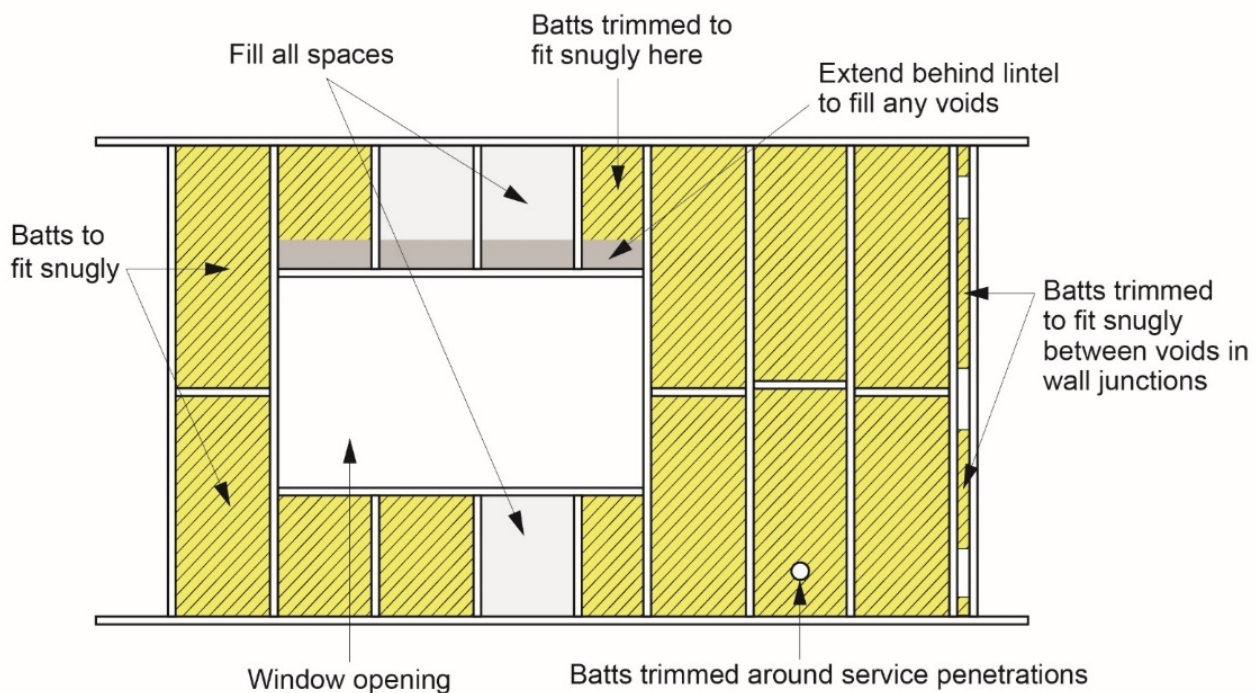

Note: Care needs to be taken when trimming bulk insulation (or 'batts') for installation. When installed, ensure that the batts still touch the framing and that no air gaps are evident between the framing and the batt.

Alert

When determining the location of the bulk and reflective insulation, consideration should be given to avoid possible condensation forming inside the layers of the building envelope particularly in certain climates and where there are high concentrations of water vapour.

The NCC contains mandatory requirements for condensation and water vapour management for houses. See NCC Volume One Part F6 for more information.

The ABCB has also produced a handbook, *Condensation in Buildings*, to assist in understanding condensation risk and the requirements contained in the NCC. The handbook can be accessed from the [ABCB website](#).

Thermal breaks

The requirements for roof and wall breaks are specified in Clauses J3D5 and J3D6, respectively and have not changed compared to NCC 2019. These apply to some metal roof and wall combinations and require a thermal break greater than or equal to R0.2.

Refer to Figure 3.7 and Figure 3.8 for the examples of roof and wall thermal break, respectively.

Alert

An important issue for roof design, especially in cooler climates where insulation with higher R-Values is required, will be to ensure that the roof structure has sufficient space to accommodate the insulation without the insulation being compressed. Any compression of the insulation will reduce its R-Value and consequently the effectiveness of the insulation.

Figure 3.7 Example of roof thermal break construction

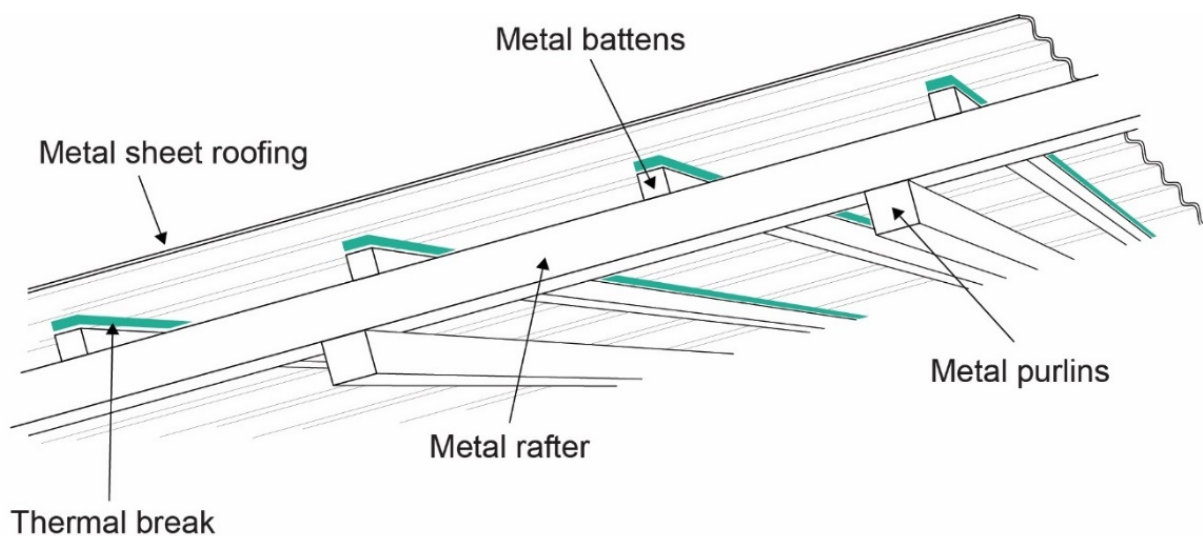
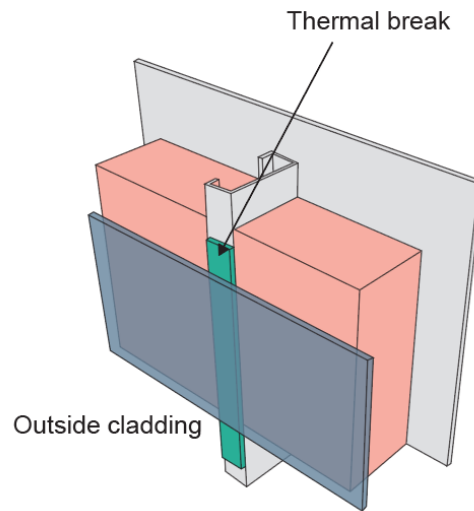

Figure 3.8 Example of wall thermal break construction**Alert**

Care should be taken to ensure the selection and installation of bulk and reflective insulation products to meet the requirements of J3D6 in Volume One, also meet other necessary requirements. For example, the condensation management requirements of Part F8.

Roofs and ceilings

The minimum thermal requirements for roofs and ceilings are specified in Clause J3D7. They primarily specify a minimum R-Value for ceiling insulation based on a range of factors such as roof construction (flat, cathedral etc.) and whether the roof is ventilated. This is similar to the approach taken for housing energy efficiency in NCC 2022 Volume Two.

The requirements recognise roof and ceiling construction elements and combinations that are better suited to the climate they are to be constructed in. i.e. these elements and combinations are rewarded with lower specifications, and still achieve a thermal rating equivalence to NatHERS of 7 stars. In addition, there are requirements to mitigate thermal bridging.

Alert: What is thermal bridging?

Thermal bridging, in practical terms for the NCC, is an unintended path of heat flow between the outside and inside of the building envelope. Thermal bridges may occur where there is an interruption in the insulation or where highly conductive materials (e.g. metal) are used. See the Glossary in Appendix B for more information.

The requirements for roofs and ceilings are summarised in Table 3.24 and discussed in more detail in the useful tips section of this chapter, see 3.2.2.



Table 3.24 Key requirements for roof and ceilings

Clause J3D7 reference	Key requirements
(1) Roof and ceiling insulation	<ul style="list-style-type: none"> • Minimum R-Values for insulation are specified in a range of look-up tables (Tables J3D7a to J3D7r) • The look-up tables provide several variables including the following: <ul style="list-style-type: none"> – roof ventilation (vented or standard) – location and performance of reflection insulation – solar absorptance – roof construction – climate zone.
(2) Reflective insulation	<ul style="list-style-type: none"> • Must have surface emittance of less than or equal to 0.05 • Must face downwards in climate zones 3 to 8 • Must face an airspace of at least 20 mm. An example is shown in Figure 3.9 Example of required airspace for reflective insulation (Explanatory Figure 10.8.3 of the Housing Provisions) .¹⁷
(3) Thermal bridging	<ul style="list-style-type: none"> • Options for pitched roof with a horizontal ceiling: <ul style="list-style-type: none"> – achieve Total R-Value in Table J3D7s using a method that can account for thermal bridging – increase R-Value required by (1) by R0.5 – adding a continuous ceiling insulation layer of at least R0.13 – stacking 2 layers of insulation on top of each other.¹⁸ • Options for a flat, skillion or cathedral roof: <ul style="list-style-type: none"> – achieve Total R-Value in Table J3D7t using a method that can account for thermal bridging – comply with Table J3D7u.

¹⁷ The air gap is to prevent beads of condensation which form on underside of reflective insulation from wicking down into bulk insulation, and to provide the ability for air from the eaves vents to get up into the main roof space.

¹⁸ The second layer of insulation will cover the ceiling framing members.



Clause J3D7 reference	Key requirements
(4) Condensation consideration due to thermal bridging	<ul style="list-style-type: none">• Continuous insulation placed above the innermost insulation layer must have a vapour permeance greater than or equal to the innermost insulation layer• Only applies when F8D5(1) applies
(5) Compensation for loss of ceiling insulation	<ul style="list-style-type: none">• When the area of the ceiling insulation is reduced due to penetrations, the insulation must be increased by complying with Table J3D7w
(6) Edge insulation options	<ul style="list-style-type: none">• Applies to attic roofs to maintain sufficient clearance of edge insulation within 450 mm of wall¹⁹<ul style="list-style-type: none">– When ceiling insulation required by (1) – (5) is greater than R3.0 and less than R4.5, edge insulation can be reduced to R3.0– When ceiling insulation required by (1) – (5) is greater than R4.5, edge insulation can be reduced to R3.0 provided the ceiling insulation is increased by R0.5.
(7) Exclusion for insulated sandwich panels	<ul style="list-style-type: none">• Requirements of J3D7(1) – J3D7(6) do not apply
(8) Insulated sandwich panels	<ul style="list-style-type: none">• Total R-Value in Table J3D7x must be achieved
(9) Roof solar absorptance limit	<ul style="list-style-type: none">• Applies in climate zones 1 to 5• Requires the solar absorptance of upper surface of roof less than or equal to R0.64

¹⁹ If there is sufficient clearance for the insulation within 450 mm of the wall, then this clause does not apply.

Figure 3.9 Example of required airspace for reflective insulation (Explanatory Figure 10.8.3 of the Housing Provisions)

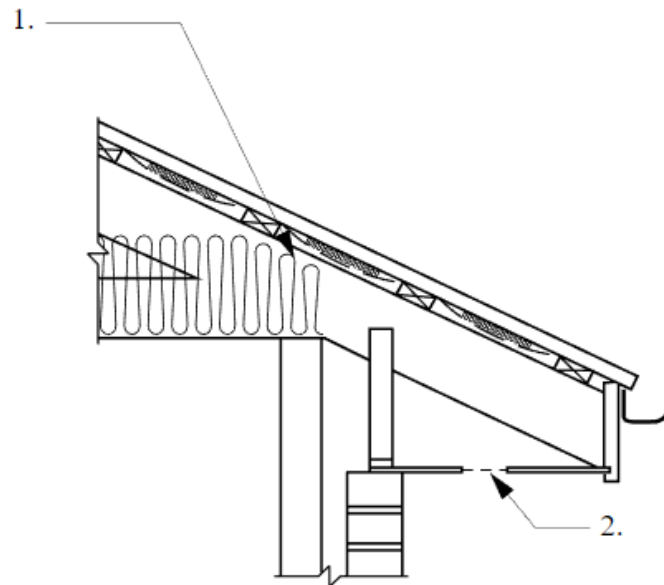

Notes to Figure 3.9 Example of required airspace for reflective insulation (Explanatory Figure 10.8.3 of the Housing Provisions) : Minimum 20 mm airspace (marked as 1) maintained for the reflective insulation as required by subclause J3D7(2)(b). Eave ventilation opening (marked as 2) in accordance with Table 10.8.3 of the Housing Provisions (for condensation management where required).

External walls

The requirements for walls are specified in J3D8. The requirements are expressed as a minimum Total R-Value. In comparison, for houses (i.e. Volume Two) the requirements are expressed as the R-Value of added insulation.

A summary of the requirements of J3D8 is shown in Table 3.25.



Table 3.25 Key requirements for external walls

J3D8 reference	Key requirements
(1) Minimum Total R-Value	<ul style="list-style-type: none"> • Minimum Total R-Value of an external wall in climate zones 1, 2, 3, 5 and 6 • Depends on the ratio of the area of opaque external walls to the floor area of an SOU, as follows: <ul style="list-style-type: none"> – must be at least R1.15 where the ratio is less than 20%. – must be at least R2.04 where the ratio is greater than or equal to 20% but less than 35%. – must be at least R2.24 where the ratio is greater than or equal to 35%. • Minimum Total R-Values of an external wall must be at least R2.24 in climate zones 4, 7 and 8
(2) Total R-Value	<ul style="list-style-type: none"> • The Total R-Value of an external wall must be determined in accordance with: <ul style="list-style-type: none"> – Specification 38, for a spandrel panel in a curtain wall system – AS/NZS 4859.2, for all other walls.
(3) Solar absorptance	<ul style="list-style-type: none"> • The solar absorptance of an external wall: <ul style="list-style-type: none"> – refer to Table J3D8a for climate zones 1 to 6 – refer to Table J3D8b for climate zones 7 and 8.

Floors

The provisions for floors of an SOU are specified in Clause J3D10. This clause focuses on concrete apartment floor slabs above carpark or similar spaces. There are no provisions to mitigate thermal bridging of an SOU in an apartment building. A summary of the requirements of J3D10 is shown in Table 3.26.

Table 3.26 Key requirements for floors

13.2.6 subclause reference	Key requirements
(1) Floor insulation – unenclosed carpark	<ul style="list-style-type: none"> • Applies to floors over unenclosed carpark, undercrofts or similar. • Minimum R-Value of underfloor insulation based on climate zone: <ul style="list-style-type: none"> – R2.0 for climate zone 2 and 5 to 8



13.2.6 subclause reference	Key requirements
(2) Floor insulation – enclosed carpark	<ul style="list-style-type: none">– R1.5 for climate zones 3 and 4. <ul style="list-style-type: none">• Applies to floors over enclosed carpark, undercrofts or similar• Minimum R-Value of underfloor insulation based on climate zone:<ul style="list-style-type: none">– R0.5 for climate zone 2– R1.0 for climate zones 4 and 5– R1.5 for climate zone 6– R2.0 for climate zones 7 and 8.
(3) CSOG insulation	<ul style="list-style-type: none">• Applies to CSOG floors that have an in-slab or in-screed heating or cooling system• Requires insulation with additional R-Value greater than or equal to R1.0 installed around the vertical edge of its perimeter
(4) Edge and under slab insulation	<ul style="list-style-type: none">• Waffle-pod slabs are exempt from the requirements of (4) in climate zones 1 to 5• Applies to floors in climate zone 6 and 7:<ul style="list-style-type: none">– insulation R-Value greater than or equal to R0.64 installed around the vertical edge of its perimeter– insulation R-Value greater than or equal to R0.64 installed underneath the slab.• Applies to floors in climate zone 8:<ul style="list-style-type: none">– insulation R-Value greater than or equal to R1.0 installed around the vertical edge of its perimeter– insulation R-Value greater than or equal to R2.0 installed underneath the slab.
(5) Insulation installation and properties	<ul style="list-style-type: none">• Applies to insulation required by (3) and vertical edge insulation required by (4)• Insulation must be installed and have the following properties:<ul style="list-style-type: none">– water resistant

13.2.6 subclause reference	Key requirements
	<ul style="list-style-type: none"> - continuous from the ground level to a depth greater than or equal to 300mm - continuous from the ground level for at least the full depth of the vertical edge of the CSOG. <ul style="list-style-type: none"> • Figure 3.10 illustrates the requirements of J3D10
(6) Exemption	<ul style="list-style-type: none"> • Requirements of (4) do not apply to an in-screed heating or cooling system used solely in a bathroom or amenity area.

Figure 3.10 Insulation of slab edge (Figure 13.2.6 of the Housing Provisions)

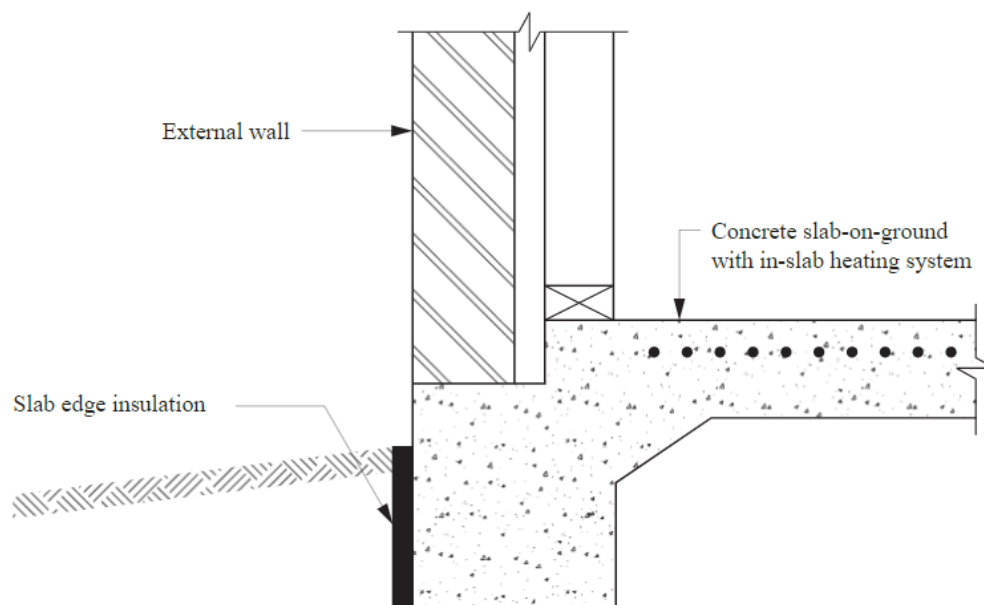

3.2.2.3 External glazing and shading

The provisions for external glazing and shading for an SOU of an apartment building or a Class 4 part of a building are in clauses J3D9, J3D11 to J3D13, as shown in Table 3.27. The intent is to control unwanted heat gain and/or loss through external glazing.



Table 3.27 External glazing and shading clauses

External glazing and shading	Clause reference
Wall-glazing construction	J3D9
Glazing winter performance	J3D11
Glazing summer performance	J3D12
Shading	J3D13

In addition to the thermal performance of the glazing itself (conductance, solar heat gain and amount of shading), the requirements are based on a range of factors, including:

- the type of room in which the glazing is located
- the number of levels in the SOU
- floor coverings
- greater window open-ability to account for cross-ventilation
- solar absorptance of window frames
- ceiling fans
- solar orientation.

Improvements to how the requirements consider summer and winter performance have also been made.

The DTS Provisions for external glazing in an SOU recognise designs that more effectively consider glazing, and the outcomes are intended to align with NatHERS software.

There are two options for assessing the external glazing for the SOUs of an apartment building.

- A combined performance assessment of walls and glazing either on a single façade or across all four directions can be used as specified in J3D9.
- Compliance of wall and window elements can be assessed separately by applying J3D8, which covers walls, and J3D11 to J3D13, which cover glazing and shading for summer and winter performance.

To assist in determining compliance when assessing external walls and glazing separately, a Glazing Calculator for an SOU in an apartment building is available from the Resource Library on the [ABCBC website](#).



Wall-glazing construction

A summary of the requirements for the combined wall and glazing option (J3D9) is shown in Table 3.28. Note that this uses the same methodology as the requirement for Class 3 to 9 building wall-glazing construction.

Table 3.28 Wall-glazing and shading clauses

J3D9 reference	Key requirements
(1) Maximum Total System U-Value	<ul style="list-style-type: none">• Applies to wall-glazing construction that forms part of the external building fabric.• The Total System U-Value must not be greater than:<ul style="list-style-type: none">– U2.2 in climate zones 1 to 5– U2.0 in climate zone 6– U1.4 in climate zones 7 and 8.
(2) Total System U-Value calculation method	<ul style="list-style-type: none">• Applies to wall-glazing construction that forms part of the external building fabric.• The Total System U-Value must be calculated in accordance with Specification 37.• Specification 37 provides 2 methods for calculating the Total System U-Value:<ul style="list-style-type: none">– single aspect, and– multiple aspect.
(3) Minimum Total R-Value	<ul style="list-style-type: none">• Applies to the wall components of the wall-glazing construction.• A minimum Total R-Value of:<ul style="list-style-type: none">– R1.0 where the wall is less than 80% of the area of the wall-glazing construction– the value specified in Table J4D6a for a Class 3 building, where the wall is greater than or equal to 80% of the area of the wall-glazing construction.
(4) Solar admittance	<ul style="list-style-type: none">• Applies to climate zones 1 to 6• The solar admittance of externally facing wall-glazing construction must be less than or equal to the value in Table J3D9.



J3D9 reference	Key requirements
(5) Total System SHGC	<ul style="list-style-type: none"> • Applies to climate zones 7 and 8 • Glazing in a wall-glazing construction must have a Total System SHGC of at least 0.4.
(6) Solar admittance calculation method	<ul style="list-style-type: none"> • Applies to the solar admittance of wall-glazing construction. • Must be calculated in accordance with Specification 37. • Specification 37 provides 2 methods for calculating the Total System U-Value: <ul style="list-style-type: none"> – single aspect, and – multiple aspect.
(7) Solar absorptance calculation method	<ul style="list-style-type: none"> • Applies to the solar absorptance of an external wall. • Must be calculated in accordance with J3D8(3).

Glazing winter performance

When assessing walls and glazing separately for an SOU, J3D11 provides the requirements for winter glazing performance. A summary of the key requirements of J3D11 is in Table 3.29.

Table 3.29 Glazing winter performance

J3D11 subclause reference	Key requirements
(1) Allowance and method	<ul style="list-style-type: none"> • Applies to climate zones 2 to 8²⁰ • Allowance = CU/CSHGC ratios in Table J3D11a • For each piece of glazing in an SOU the CU/CSHGC ratio less than or equal to allowance • For each glazing element in an SOU the CU/CSHGC ratio must be determined using the method in (1)(b)²¹
(2) Method inputs and their location	<ul style="list-style-type: none"> • Method inputs for each piece of glazing: <ul style="list-style-type: none"> – A = area – U = Total System U-Value – SHGC = Total System SHGC²²

²⁰ The requirements do not apply to climate zone 1 as there is no need for artificial or passive heating.

²¹ See NCC Volume One for a copy of the full method. An excerpt is shown in Appendix D.3.

²² The SHGC must not exceed 0.7 for any piece of glazing.



J3D11 subclause reference	Key requirements
	<ul style="list-style-type: none"> – E_w = winter exposure factor. • Method inputs: <ul style="list-style-type: none"> – BC = bedroom conductance factor – OC = orientation sector conductance factor – R_w = room type factor – BS_w = bedroom solar heat gain factor – F_w = frame factor – H_w = floor factor. • Location of inputs in Volume One: <ul style="list-style-type: none"> – E_w – Tables J3D11b to J3D11g – BC – Tables J3D11h to J3D11m – OC – Table J3D11n – R_w -Tables J3D11h to J3D11m – BS_w -Tables J3D11h to J3D11m – F_w – Tables J3D11o to J3D11t – H_w – Tables J3D11h to J3D11m.
(3) Shading	<ul style="list-style-type: none"> • Orientation sectors must be determined through the application of Figure 13.3.2a of the ABCBC Housing Provisions Standard • The projection (P)/height (H) ratio of shading must be determined in accordance with Figure S37C7 • For P/H between those in Tables J3D11b to J3D11g, either use the next highest P/H or interpolate. • See Figure 3.11 for an illustration

Note to Table 3.29: Unlike the calculation for housing, the level factor is not considered.



Figure 3.11 Permanent external shading-measurement of P, G and H

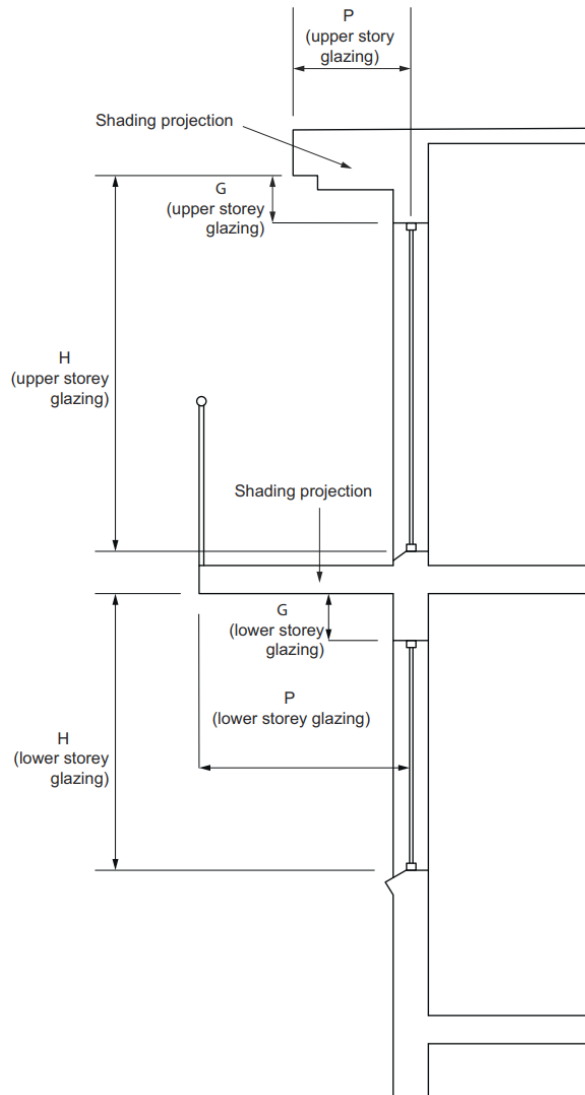

Glazing summer performance

A summary of the key requirements of J3D12 for glazing performance during summer is in Table 3.30.



Table 3.30 Glazing summer performance

J3D12 reference	Key requirements
(1) Allowance and method	<ul style="list-style-type: none"> • Applies to climate zones 1 to 7²³ • Allowance = floor area of storey x C_{SHGC} from Table J3D12a • The combined solar heat gain from glazing \leq allowance • The combined solar heat gain from glazing must be determined using the method in (1)(b)²⁴
(2) Method inputs and their location	<ul style="list-style-type: none"> • Method inputs for each piece of glazing: <ul style="list-style-type: none"> – A = area – SHGC = Total System SHGC²⁵ \leq 0.7 – E_S = summer exposure factor – R_S = room type factor²⁶ – F_S = frame factor – H_S = floor factor. • Location of inputs in the Housing Provisions: <ul style="list-style-type: none"> – E_S – Tables J3D12b to J3D12h – R_S, F_S and H_S -Tables J3D12i or Table J3D12j.
(3) Shading	<ul style="list-style-type: none"> • Orientation sectors must use Figure 13.3.2a of ABCB Housing Provisions • The projection (P)/height (H) ratio of shading must be determined in accordance with Figure S37C7. See Figure 3.11 for an illustration • Linear interpolation or the next highest P/H is applied for P/H between those shown in Tables J3D12b to J3D12

Shading

Clause J3D13 provides the shading requirements for external glazing. The requirements apply to any shading that was needed to comply with the external glazing requirements for winter or summer performance (i.e. clauses J3D11 and J3D12 that are discussed above).

²³ The requirements do not apply to climate zone 8 as there is no need for artificial or passive cooling.

²⁴ See the NCC Volume One for a copy of the method. An excerpt is shown in Appendix D.3.

²⁵ The SHGC must not exceed 0.7 for any piece of glazing.

²⁶ Applies to bedrooms or rooms that are not a conditioned space.



A summary of the key requirements for shading of external glazing is in Table 3.31.

Table 3.31 Key requirements for shading of external glazing

J3D13 subclause reference	Key requirements
(a) Permanent shading	<ul style="list-style-type: none"> • Shading can be provided by an external permanent projection that may include any of the following: <ul style="list-style-type: none"> – verandah – balcony – fixed canopy – eaves – shading hood – carport. • Permanent shading must extend horizontally on both sides of the glazing for a distance that is greater than or equal to the projection distance P (see Figure 3.11) or provide equivalent shading with a reveal.
(b) Shading device	<ul style="list-style-type: none"> • Shading can be provided by an external shading device that may include any of the following: <ul style="list-style-type: none"> – shutter – blind – vertical or horizontal external screen with blades, battens or slats. • Shading devices must be able to restrict greater than or equal to 80% of summer solar radiation • An occupant of an SOU should be able to easily operate an adjustable shading device either manually, mechanically or electronically

3.2.2.4 Building sealing

Part J5 Building sealing in Volume One contains the relevant DTS Provisions to adequately seal parts of a building. The intent is to restrict air infiltration and air exfiltration.²⁷ Unintended leakage

²⁷ See the terms 'air infiltration and 'air exfiltration' in the Glossary at Appendix B for more information.



can lead to greater heat losses or gain and therefore reduced thermal comfort of occupants and consequently, increase the use of artificial heating and/or cooling.

Relevant clauses on building sealing are outlined in Table 3.32 and discussed in the following sections.

Table 3.32 Building sealing clauses

Building element	Clause reference
Application	J5D2
Chimneys and flues	J5D3
Roof lights	J5D4
Windows and doors	J5D5
Exhaust fans	J5D6
Construction of ceilings, walls and floors	J5D7
Evaporative coolers	J5D8

Application of Part

Clause J5D2 specifies the DTS Provisions for building sealing applying to the elements forming the envelope of a Class 2 to 9 building.

There are 3 exemptions.

- (1) A permanent building opening, in a space where a gas appliance is located, that is necessary for the safe operation of a gas appliance.
- (2) A building or space where the mechanical ventilation required by Part F6 provides sufficient pressurisation to prevent infiltration.
- (3) A building in climate zones 1, 2, 3 and 5 where the only means of air-conditioning is by using an evaporative cooler.

Alert

Appropriate ventilation requirements for gas appliances can be obtained from relevant state and territory legislation, referenced standards and product installation manuals.

Chimneys and flues

Clause J5D3 requires a solid-fuel burning appliance (e.g. wood fireplace) to have a damper or flap on its chimney or flue so that it can be closed. The intent of this requirement is to prevent conditioned air being drawn up the chimney or flue when the appliance is not in use.



Roof lights

Clause J5D4 provides the minimum sealing requirements for roof lights (skylights). The skylight sealing requirements consist of 2 subclauses. The key requirements of these subclauses are summarised in Table 3.33.

Table 3.33 Key requirements to seal skylights

Clause J5D4 reference	Key requirements
(1) Application	<ul style="list-style-type: none">• Skylights must be sealed, or capable of being sealed in the following locations:<ul style="list-style-type: none">– A conditioned space– A habitable room in climate zones 4, 5, 6, 7 and 8.
(2) Sealing requirements	<ul style="list-style-type: none">• Sealing can be achieved by any of the following:<ul style="list-style-type: none">– A ceiling diffuser (no holes)– A weatherproof seal– A manual, mechanical or electronic shutter system

Windows and doors

Clause J5D5 provides the minimum sealing requirements for windows and doors. The requirements consist of 2 subclauses. The key requirements are summarised in Table 3.34.

Table 3.34 Key requirements to seal windows and doors

Clause J5D5 reference	Key requirements
(1) Application	<ul style="list-style-type: none">• Applies to the following doors, openable windows and similar openings:<ul style="list-style-type: none">– when they form part of the building envelope– are in climate zones 4, 5, 6, 7 or 8.
(2) Sealing requirements	<ul style="list-style-type: none">• A draft protection device must be used to seal the bottom edge of a door• A foam or rubber compressible strip, or fibrous seal, must be used to seal the other edge of doors and openable windows
(3) Exemption	<ul style="list-style-type: none">• A windows that comply with AS 2047• Fire doors or smoke doors



Clause J5D5 reference	Key requirements
	<ul style="list-style-type: none"> Roller shutter doors, roller shutter grille or other security doors or devices

Exhaust fans

Clause J5D6 sets out the requirements to self-exhaust fans.

Exhaust fans must be sealed with a self-closing damper or filter when located in one of the following:

- A conditioned space.
- A habitable room in climate zones 4, 5, 6, 7 or 8.

Construction of ceilings, walls and floors

Clause J5D7 provides the minimum requirements to seal ceilings, walls and floors at junctions and around window and door penetrations.

The requirements consist of 2 subclauses. A summary of the key requirements is outlined in Table 3.35.

Table 3.35 Key construction requirements to seal ceilings, walls and floors

Clause J5D7 reference	Key requirements
(1) Application	<ul style="list-style-type: none"> Applies to the following components of the envelope: <ul style="list-style-type: none"> ceilings floors window frames door frames skylight frames. Seals are needed for climate zones 4, 5, 6, 7 or 8.
(2) Construction requirements	<ul style="list-style-type: none"> Option 1: Construction in (1) must be enclosed by internal lining systems that are close-fitting for the following construction elements: <ul style="list-style-type: none"> ceilings walls and floor junctions. Option 2: Construction in (1) must be sealed at junctions and penetrations by either of the following:



Clause J5D7 reference	Key requirements
	<ul style="list-style-type: none"> – close-fitting architraves, skirting or cornices – expanding foam, rubber compressive strip or caulking.
(3) Exemption	<ul style="list-style-type: none"> • Openings, grilles or the like required for smoke hazard management.

Evaporative coolers

Clause J5D8 provides the minimum requirements to seal evaporative coolers. Evaporative coolers must be sealed with a self-closing damper when supplying a heated space, or located in climate zone 4, 5, 6, 7 or 8.

3.2.2.5 WOH energy usage

J3D14 covers the WOH energy usage of an SOU of an apartment building and is new for NCC 2022. The intent is to reduce the energy use of a new SOU in an apartment building. The requirements holistically consider:

- the efficiency of fixed²⁸energy-using equipment, such as heating and cooling equipment, heated water, lighting, and pool and spa pumps, and
- on-site renewable energy generating systems, such as rooftop solar photovoltaics (PV).

By using an ‘annual energy use allowance’, the WOH energy usage requirements allow trading between the efficiency of energy-using equipment, as well as off-setting through energy generated onsite. Together, this approach allows flexibility and enables cost-effective solutions to reduce overall energy consumption.

Alert

The DTS Provisions for WOH energy usage in J3D14 and the DTS Provisions for Services in Part J6 and J7 contain requirements for an apartment’s domestic services and both parts need to be met. This should be considered during the selection of the domestic services, including the size of any on-site renewable energy such as rooftop solar PV and the heated water service.

Figure 3.12 illustrates the annual energy use allowance approach based on the WOH energy usage requirements.

²⁸ Portable appliances and equipment are excluded.



Figure 3.12 Annual energy use allowance approach

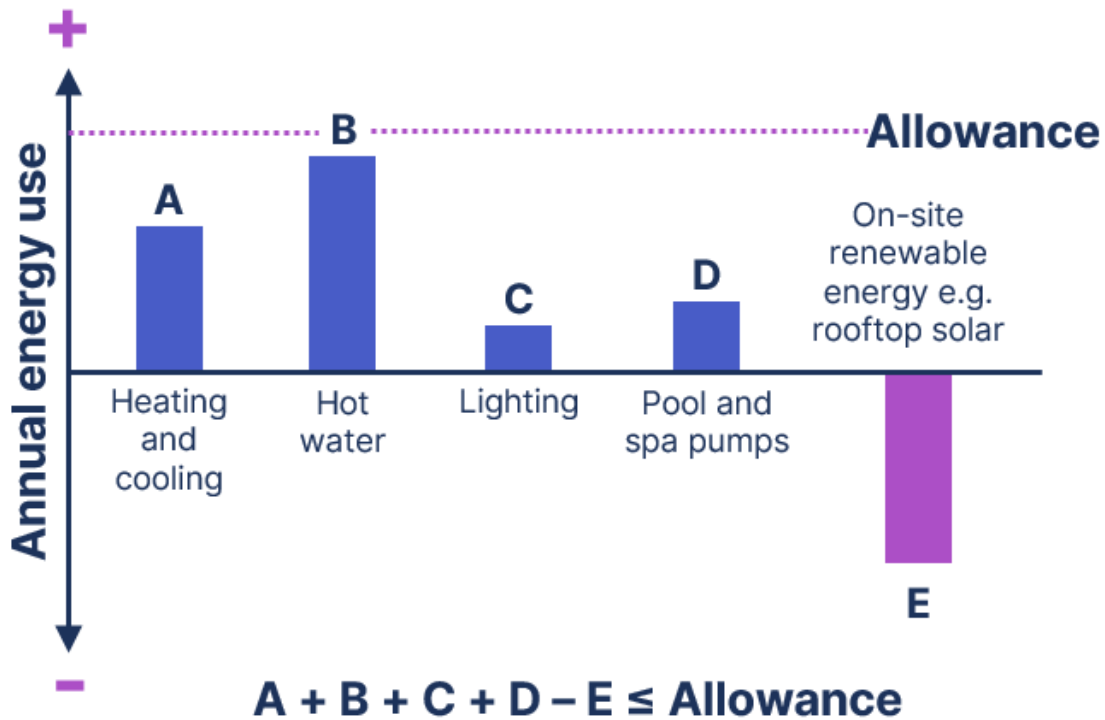

Within J3D14, there are 2 clauses that need to be met. These are discussed in the following sections.

To assist determining compliance, a calculator is available that automates the calculations required. The Whole-of-home Calculator is available from the [ABCBC website](#).

Alert

Centralised hot water systems in Class 2 apartment buildings do not have a DTS pathway in NCC 2022. A Performance Solution, such as J1V5 Verification using a reference building for a Class 2 sole-occupancy unit, must be developed for a proposed Class 2 building with a centralised hot water system.

Application

The DTS Provisions for WOH energy usage apply to an SOU in an apartment building.

The DTS Provisions for WOH energy usage can only be used for an SOU that has a total floor area less than or equal to 500 m². For an SOU with a floor area greater than 500 m², another compliance option must be used. See Section 2.4 for other options.

The application of the WOH energy usage requirements is specified in NCC Volume One J2D2(3)(b) and J3D14.



Net equivalent energy use (annual energy use)

J3D14 provides the method to determine the annual energy use of an SOU and the annual energy use allowance.

The requirements consist of 3 subclauses. A summary of the key requirements of these subclauses is in Table 3.36.

Table 3.36 Key requirements for annual energy use

J3D14 subclause reference	Key requirements
Method (1)(a) and allowance (1)(b)	<ul style="list-style-type: none"> • Method is provided in a calculation and requires the following inputs: <ul style="list-style-type: none"> – A = floor area factor – E_E = main space conditioning and main water heater efficiency factors – E_P = swimming pool pump usage – E_S = spa pump energy usage – E_R = capacity of installed on-site photovoltaics (kW) apportioned to the SOU • Allowance is provided in a calculation and requires the following inputs: <ul style="list-style-type: none"> – A = floor area factor – E_F = energy factor (based on location) • Location of inputs in the Housing Provisions: <ul style="list-style-type: none"> – A – total floor area of SOU and Table J3D14a – E_E – ABCB Standard for Whole-of-Home Efficiency Factors (2022) available from the ABCB website – E_P – see (2) – E_S = see (3) – E_F = Table J3D14b
(2) Swimming pool pump energy method	<ul style="list-style-type: none"> • To determine E_P, the method requires the following inputs: <ul style="list-style-type: none"> – V = volume of swimming pool²⁹

²⁹ To nearest 1000 litres



J3D14 subclause reference	Key requirements
(3) Spa pool pump energy method	<ul style="list-style-type: none"> – F_p = swimming pool pump factor (see Table 13.6.2c of the Housing Provisions) <ul style="list-style-type: none"> • To determine ES, the method requires the following inputs: <ul style="list-style-type: none"> – V = volume of spa pool³⁰ – F_s = spa pool pump factor (see Table 13.6.2d of the Housing Provisions)

3.2.2.6 Air-conditioning and ventilation

Part J6 sets out the provisions for the efficiency and control of air-conditioning and ventilation.

This includes air-conditioning, space heating and ventilation equipment, the efficiency, sealing and insulation requirements for ductwork systems containing fans, and for the efficiency and insulation of pipework and pump systems. Note that there may be instances where clauses in Part J6 will not apply within an SOU because the equipment being covered will not be present within the SOU itself.

The relevant J6 clauses for different services are outlined in Table 3.37.

Table 3.37 Air-conditioning and ventilation clauses

Service	Clause reference
Application	J6D2
Air-conditioning system control	J6D3
Mechanical ventilation system control	J6D4
Fans and duct systems	J6D5
Ductwork insulation	J6D6
Ductwork sealings	J6D7
Pump systems	J6D8
Pipework insulation	J6D9
Space heating	J6D10
Unitary air-conditioning equipment	J6D12

³⁰ To nearest 100 litres.



Note to Table 3.37: These clauses generally apply to an apartment building except for some clauses where they do not apply if there is only one SOU.

Application

The DTS Provisions for air-conditioning and ventilation specified in Part J6 cover several classes of buildings including an SOU in an apartment building.

Air-conditioning system control

The requirements for air-conditioning system control are summarised in Clause J6D3. The requirements relevant to an SOU are outlined in Table 3.38. Clause J6D3(f) is not relevant to an SOU.

Table 3.38 Key requirements for air-conditioning system control

J6D3 reference	Key requirements
(1) An air-conditioning system.	<ul style="list-style-type: none"> • Must be capable of being deactivated when the building or part of that building served by that system is not occupied • When serving more than one air-conditioning zone or area with different heating or cooling needs, must: <ul style="list-style-type: none"> – thermostatically control the temperature of each zone or area – not control the temperature by mixing actively heated/cooled air – limit reheating to not more than a 7.5K rise in temperature at a fixed supply air rate as well as at the nominal supply air rate for a variable supply air rate. • Possess an outdoor air economy cycle function according to Table J6D3 • Capable of stopping the flow of water to those not operating • With an airflow of more than 1000 L/s, must have a variable speed fan when its supply air quantity is capable of being varied • Use direct signals to regulate the operation of central plant. • A control dead band of not less than 2°C in general • Provided with balancing dampers and balancing valves to ensure achieving the maximum design air/fluid flow, but not



J6D3 reference	Key requirements
	<p>exceeded by more than 15% for each component or group of components</p> <ul style="list-style-type: none"> • Automatic variable temperature operation of heated water and chilled water circuits • Close any motorised outdoor air or return air damper that is not otherwise being actively controlled
(2) Two or more air-conditioning systems.	<ul style="list-style-type: none"> • Control sequences must be used when two or more air-conditioning systems serve the same space
(3) Time switches.	<ul style="list-style-type: none"> • Time switches must be provided as follows <ul style="list-style-type: none"> – When controlling an air-conditioning system of more than 2 kW_r and a heater of more than 1 kW_{heating} – Be capable of switching electric power on and off at variable pre-programmed times and on variable pre-programmed days. • The above requirements do not apply to: <ul style="list-style-type: none"> – an air-conditioning system that serves only one SOU in an apartment building – a Class 4 part of a building – an conditioned space where air-conditioning is needed for 24 hour continuous use.

Mechanical ventilation system control

Clause J6D4 specifies the requirements for a mechanical ventilation system control. Table 3.39 outlines the key requirements for J6D4.

Table 3.39 Key requirements for mechanical ventilation systems

J6D4 reference	Key requirements
(1) General	<ul style="list-style-type: none"> • Specifies requirements for mechanical ventilation system control, except for systems which serve a single SOU in an apartment building or a Class 4 part of a building • Be capable of being deactivated when the building or part of the building it serves is unoccupied • When serving a conditioned space, except when an evaporative cooler is in use:



	<ul style="list-style-type: none"> - Have energy reclaiming systems for systems specified in J6D4 - Demand control ventilation as per AS 1668.2 for systems specified in J6D4. • Not exceed minimum outdoor air requirements of F6 except where: <ul style="list-style-type: none"> - free cooling of the system is supplied by additional unconditioned outdoor air - the required exhaust or process exhaust needs additional mechanical ventilation - outdoor air is preconditioned by an energy reclaiming system. • Have a variable speed fan for systems with an airflow of 1000 L/s or more, except if downstream airflow is required by Part F6
(2) Exhaust systems	<ul style="list-style-type: none"> • Not applicable to exhaust systems in an SOU of a Class 2 building
(3) Carpark exhaust systems	<ul style="list-style-type: none"> • Not applicable to exhaust systems in an SOU of a Class 2 building
(4) Time switches	<ul style="list-style-type: none"> • Be provided to mechanical ventilation systems with an air flow for 100 L/s or more • Be capable of switching electric power on or off at variable pre-programmed times and on variable pre-programmed days • Exemptions: <ul style="list-style-type: none"> - Mechanical ventilation system that serves a single SOU in a Class 2 building - A Class 4 part of a building - Where mechanical ventilation is needed for 24 hour occupation.

Fans and duct systems

Clause J6D5 sets out requirements for fans, ductwork and duct components used as part of an air-conditioning system or mechanical ventilation system. The key requirements for J6D5 are in Table 3.40.



Table 3.40 Key requirements for fan and duct systems

J6D5 reference	Key requirements
(1) Application	<ul style="list-style-type: none">Fans, ductwork and ducts in an air-conditioning or mechanical ventilation system must:<ul style="list-style-type: none">Option1 - separately comply with the requirements for fans, ductwork and ductsOption 2 – achieve a fan motor input power per unit of flowrate lower than the fan motor input power per unit of flowrate of (2) – (5) combined.
(2) Fans	<ul style="list-style-type: none">Fans must have a minimum efficiency at full load calculated as outlined in J6D5(2)J6D5(2) has separate calculation methods for systems with static pressure of 200 Pa or less, and above 200 Pa
(3) Ductwork	<ul style="list-style-type: none">Pressure drop in the index run must not exceed 1 pa/m³¹Flexible ductwork must not be more than 6m in any duct runBends, elbows and tees must have an equivalent diameter to the duct they are connected toTurning vanes to be included in all rigid ductwork elbows of 90° or less except:<ul style="list-style-type: none">when their inclusion presents a fouling riska long radius bend in accordance with AS 4254.2 <p>Ductwork for air-handling systems in buildings – Rigid duct, is used.</p>

³¹ Averaged over the entire length of duct. The pressure drop of flexible ductwork sections may be calculated as if flexible ductwork is laid straight.



J6D5 reference	Key requirements
(4) Ductwork components	<ul style="list-style-type: none">• Set outs requirements for ductwork components in the index run and cover the following:<ul style="list-style-type: none">– pressure drop across coils– high efficiency particulate arrestance (HEPA) air filters– other air filters– intake louvres– variable air volume boxes– rooftop cowls– attenuators– fire dampers– balancing and control dampers– supply air diffusers– exhaust grilles– transfer ducts– door grilles– active chilled beams.
(5) Exemptions	<ul style="list-style-type: none">• The requirements of (1) to (4) don't apply to:<ul style="list-style-type: none">– fans in unducted air-conditioning systems with a capacity of less than 1000 L/s– smoke spill fans– the power for process-related components– kitchen exhausts.

Note to Table 3.40: Application of J6D5 (1) to (4) to an SOU in a Class 2 building or a Class 4 part of a building are dependent on the design of the air-conditioning system.

Ductwork insulation

J6D6 sets out the requirements to reduce energy loss, ductwork and fittings in an air-conditioning system need to be insulated. The key requirements for J6D6 can be found in Table 3.41.



Table 3.41 Key requirements for ductwork insulation

J6D6 reference	Key requirement
(1) Application	<ul style="list-style-type: none">• Specifies that insulation for ductwork and fittings for air-conditioning systems must:<ul style="list-style-type: none">– comply with AS 4859.1 Thermal insulation materials for building – General criteria and technical provisions– have a minimum insulation R-Value of:<ul style="list-style-type: none">○ R1.0 for flexible ductwork, or○ for cushion boxes equivalent to connecting ductwork, or○ comply with Table J6D6.
(2) Installation of ductwork insulation	<ul style="list-style-type: none">• Insulation must:<ul style="list-style-type: none">– be protected from the weather– abut adjacent insulation to form continuous layer– maintain its thickness other than at flanges or supports– be protected by a vapour barrier on the outside of the insulation when conveying cool air. The vapour barrier must be installed so adjacent layers overlap by 50mm and bonded or taped together.
(3) Exemptions	<ul style="list-style-type: none">• The requirements of (1) do not apply to:<ul style="list-style-type: none">– ductwork and fittings located in the only or last room served by the system– fittings that form part of the interface with the conditioned space– return air ductwork which are in, or passing through a conditioned space– ductwork for outdoor air and exhaust air associated with an air-conditioning system.– the floor of an in-situ air-handling unit– packaged air conditioners, split systems and variable refrigerant flow air-conditioning equipment complying with Minimum Energy Performance Standards (MEPS)– flexible fan connectors.
(4) Fittings	<ul style="list-style-type: none">• Include non-active components of a ductwork system such as cushion boxes• Exclude active components such as air-handling unit components



Ductwork sealing

J6D7 specifies the sealing of ductwork for large air-conditioning systems (capacity of 3000 L/S or greater). It specifies ductwork that is not located within the only or last room served by the system must be sealed from loss in accordance with AS 4254.1 and AS4254.2

Pump systems

J6D8 set out the minimum requirements for pumps which form part of an air-conditioning system. Table 3.42 summarises the key requirements of J6D8.

Table 3.42 Summary of key requirements for pumps

J6D8 reference	Key requirements
(1) Application	<ul style="list-style-type: none"> Pumps and pipework which form part of an air-conditioning system must: <ul style="list-style-type: none"> separately comply with J6D8 (2) to (4) achieve a pump motor power per unit of flow rate lower than the pump motor power per unit of flowrate achieved when applying the provisions of J6D8.
(2) Circulator pumps	<ul style="list-style-type: none"> Glandless impeller pump with a rated output of less than 2.5 kW and used in closed loop systems Energy efficiency index (EEI) less than 0.27 EEI must be calculated in accordance with European Union Commission Regulation No. 622/2012.
(3) Other pumps	<ul style="list-style-type: none"> Other pumps must be in accordance with European Union Commission No. 547/2012 articles No. 1 and 2. EEI of at least 0.4. EEI must be calculated in accordance with European Union Commission Regulation No. 622/2012
(4) Pipework	<ul style="list-style-type: none"> Applies to straight sections of pipework along the index run that form part of the air-conditioning system. For pipework systems that do not have any branches and have the same flow rate through the entire network, an average pressure drop less than the value specified in Table J8D8a or J8D8b. For any other pipework system, an average pressure drop less than the value specified in Table J8D8c or J8D8d.



J6D8 reference	Key requirements
(5) Exemptions	<ul style="list-style-type: none"> • (4) does not apply to: <ul style="list-style-type: none"> – valves and fittings – pipework, where the smallest pipe size compliant with (4) results in a velocity of less than 0.7 m/s design flow.

Pipework insulation

J6D9 specifies the DTS requirements for pipework insulation for piping, vessels and tanks which contain heating or cooling fluids. Table 3.43 provides a summary of the key requirements for J6D9.

Table 3.43 Summary of requirements for pipework insulation

J6D9	Key requirements
(1) Application	<ul style="list-style-type: none"> • Requires insulation for piping, vessels, heat exchangers and tanks containing heating and cooling fluid held at a heated or cooled temperature • Insulation must: <ul style="list-style-type: none"> – comply with AS4859.1 – for piping used heating and cooling, have an R-Value in accordance with Table J6D9a – for vessels, heat exchangers or tanks, have insulation in accordance with Table J6D9b – for refill or pressure relief piping, have insulation with an R-Value equal to the required insulation value of the connected pipe, vessel or tank within 500 mm of the connection.
(2) Insulation installation	<ul style="list-style-type: none"> • Insulation must be: <ul style="list-style-type: none"> – protected against the effects of weather and sunlight – able to withstand the temperatures within the piping, vessel, heat exchanger or tank.
(3) Vapour barrier protection	<ul style="list-style-type: none"> • Vapour barriers are required to be installed on the outside of insulation provided for piping, vessels, heat exchangers or tanks



(4) Exemptions	<ul style="list-style-type: none"> • The requirements of (1) and (2) do not apply to piping, vessels or heat exchangers: <ul style="list-style-type: none"> – located in the only or last room served by the system and downstream of the control device for the regulation of heating or cooling service to that room – encased within concrete slab or panel which is part of a heating or cooling system – supplied as an integral part of a chiller, boiler or unitary air-conditioner complying with the requirements of J6D 10 to J6D12 – inside an air-handling unit, fan-coil unit or similar.
(5) Definitions	<ul style="list-style-type: none"> • For the purposes of (1) to (4): <ul style="list-style-type: none"> – heating fluids include refrigerant, heated water, steam and condensate – cooling fluids include refrigerant, chilled water, brines and glycol mixtures but do not include condenser cooling water.

Alert

AS 4859.1 specifies requirements and methods of testing of materials that are used in opaque envelopes of buildings and building services to provide thermal insulation. This includes ductwork and pipework. DTS Provisions are based on AS 4859.1 calculation methods.

Space heating

The minimum requirements for space heating can be found in J6D10. Table 3.44 summarises the key requirements for J6D10.

Table 3.44 Summary of requirements for space heating

J6D10 reference	Key requirements
(1) Heaters	<ul style="list-style-type: none"> • Specifies that heaters used for air-conditioning must be one of the following: <ul style="list-style-type: none"> – a solar heater – a gas heater – a heat pump heater



	<ul style="list-style-type: none">– a heater which reclaims heat from another process– an electric heater– any combination of the above.• An electric heater must have the following properties:<ul style="list-style-type: none">– a heating capacity of 10 W/m² for climate zone 1– a heating capacity of 10 W/m² for climate zone 2– a heating capacity as specified in Table J6D10 where reticulated gas is not available to the allotment boundary– an annual energy consumption of 15 kWh/m² or less for climate zones 1 to 5– an in-duct heater must comply with J6D3(1)(b)(iii)
(2) Bathroom heating	<ul style="list-style-type: none">• Bathrooms in an apartment building can be heated with an electric heater with a capacity of 1.2 kW or less.
(3) Outdoor spaces	<ul style="list-style-type: none">• Where a fixed heating or cooling appliance moderates the temperature of an outdoor space, it must be able to automatically shutdown when:<ul style="list-style-type: none">– there are no occupants– it has been running for an hour– the space has reached the designed temperature.
(4) Gas water heater	<ul style="list-style-type: none">• Where a gas water heater is used as part of an air-conditioning system it must<ul style="list-style-type: none">– achieve a minimum gross thermal efficiency of 86%, if rated to consume 500 MJ/hour of gas or less– achieve a minimum gross thermal efficiency of 90% if rated to consume more than 500 MJ/hour of gas.

Unitary air-conditioning equipment

J6D12 specifies the minimum requirements for unitary air-conditioning equipment. Table 3.45 provides a summary of the key requirements of J6D12.



Table 3.45 Summary of unitary air-conditioning equipment

J6D12(1) reference	Key requirement
(a) Cooled water	<ul style="list-style-type: none"> Air-conditioning equipment must have a minimum energy efficiency ratio of $4.0 W_r/W_{inputpower}$ for cooling in accordance with AS/NZS 3823.1.2³², at test condition T1.
(b) Cooled air	<ul style="list-style-type: none"> Air-conditioning equipment must have a minimum energy efficiency of $2.9 W_r/W_{inputpower}$ cooling in accordance with AS/NZS 3823.1.2 at test condition T1

3.2.2.7 Artificial lighting and power

Part J7 aims to limit unreasonable energy use from artificial lighting and power. The requirements only apply to artificial lights that are permanently installed.

To produce the same light output, different lighting systems use different amounts of energy. The NCC requirements recognise lighting systems that use technology such as timers or dimmers to reduce energy consumption.

Apart from clause numbering, the DTS Provisions for artificial lighting and power are unchanged for NCC 2022 when compared to NCC 2019.

A summary of the relevant clauses on artificial lighting and power that apply to an SOU of an apartment building is outlined in Table 3.46.

Table 3.46 Artificial lighting and power clauses

Artificial lighting and power	Clause reference
Application	J7D2
Artificial lighting	J7D3
Interior artificial lighting and power control	J7D4
Interior decorative and display lighting	J7D5
Exterior artificial lighting	J7D6

To assist in determining compliance, a Lighting Calculator is available from the Resource Library on the [ABCB website](#).

³² AS/NZS 3823.1.2 Performance of electrical appliances – Air conditioners and heat pumps – Ducted air conditioners and air-to-air heat pumps – Testing and rating for performance.



Application

Part J7 sets out the application of the requirements for artificial lighting and power. It applies to an SOU in an apartment building, including several other building classifications.

Artificial lighting

A summary of the key artificial lighting requirements for an SOU is provided in Table 3.47.

Table 3.47 Key requirements for artificial lighting in an SOU

J7D3 subclause reference	Key requirements
(1) Allowances for an SOU in a Class 2 building	<ul style="list-style-type: none"> • Lamp power density or illumination power density allowances: <ul style="list-style-type: none"> – less than or equal to 5 W/m² in an SOU – less than or equal to 4 W/m² on a verandah or balcony or like attached to a SOU. • The illumination power density allowance can be increased by applying illumination power density adjustment factors (Table J7D3b) • The power of the proposed installation must be used rather than nominal allowances of complete light fittings • Halogen lights must be separately switched from fluorescent lights, as halogen lights consume more energy
(3) Exemptions	<ul style="list-style-type: none"> • The requirements of (1) do not apply to the following: <ul style="list-style-type: none"> – emergency lighting provided in accordance with Part E4 – a heater where the heater also emits light, such as in bathrooms – lighting installed solely to provide photosynthetically active radiation for indoor plant growth on green walls and the like.
(4) Additional requirements	<ul style="list-style-type: none"> • Following Table J7D3b, the following control devices must comply with Specification 40: <ul style="list-style-type: none"> – lighting timers – motion detectors – daylight sensors and dynamic lighting control devices.

In addition to the requirements of J7D3, J7D4 and J7D5 contain requirements for an SOU in a Class 2 building. Not all clauses in J7D4 and J7D5 apply to SOUs.

A summary of the applicable clauses from J7D4 and J7D5 is in Table 3.48.



Table 3.48 Summary of key requirements from J7D4 and J7D5

Clause reference	Key requirement
J7D4 (1)	<ul style="list-style-type: none">Artificial lighting in a room or space must be individually controlled by a switch, other control device, or combination of these 2
J7D4 (3) (a)	<ul style="list-style-type: none">Artificial lighting switches must be located:<ul style="list-style-type: none">in visible and easily accessed locationsin the room or space being switched or in an adjacent room or space, where 90% of the lighting being controlled is visible.

Exterior artificial lighting

Clause J7D6 requirements cover external lighting attached to or directed at the façade of a building. A summary of clauses in J7D6 is in Table 3.49.

Table 3.49 Key requirements for exterior artificial lighting

J7D6 reference	Key requirement
(1) Exterior lighting	<ul style="list-style-type: none">Provides controls for exterior lighting directed or attached the façade of a buildingMust be controlled by day light sensors or time switchesOptions for when total lighting load exceeds 100 W:<ul style="list-style-type: none">Option 1 - Use LED luminaires for 90% of the total lighting loadUse motion detectors in accordance with Specification 40Have a separate time switch in accordance with Specification 40 when used for decorative purposes.
(2) Exemption	<ul style="list-style-type: none">(1)(b) does not apply to emergency lighting in accordance with Part E4



3.2.3 Useful tips

3.2.3.1 Thermal insulation

- In addition to meeting the DTS Provisions for energy efficiency, the selection and installation of reflective and bulk insulation must meet other NCC requirements such as Part F8 Condensation management of NCC Volume One.
- The WOH requirements for an SOU are different to those for houses. This is because people living in an SOU usually face greater constraints on installing solar panels to offset their energy costs than people living in detached houses. Given this, the WOH energy allowance for an SOU in an apartment building is larger compared to a detached house.

3.2.3.2 Roofs and ceilings

- The requirements for roofs and ceilings set out in J3D7 apply only to SOUs who have an external roof immediately above them. For example, SOUs on the top level of an apartment building.
- If a roof is not 'vented', it is considered a 'standard' roof since it does not meet the additional ventilation requirements described above.
- Roof allowances only apply to pitched roofs with a horizontal ceiling. They do not apply to a flat, skillion or a cathedral roof.
- Minimum R-Values are not available for every combination of variables (e.g. roof ventilation, solar absorptance, etc.) when using the DTS elemental provisions. Alternative options include identifying a different combination of variables which comply, or another compliance option. Refer to Section 2.4 for a summary of compliance options for meeting the Performance Requirements of the NCC.
- The effect of reflective insulation in a roof changes depending on the internal and external conditions at a point in time. This means they cannot be accurately represented by a single R-Value for the dominant heat flow direction. Similarly, roof ventilation has a highly variable impact.
- For these reasons, separate R-Values are provided for roofs with and without reflective insulation as well as roofs with and without roof ventilation.
- The requirements for roof solar absorptance values are calibrated to the climate zone (e.g. light roofs allow lower R-Values in cooling-dominated climates and darker roofs allow lower R-Values in heating-dominated climates).



3.2.3.3 External walls

- For a spandrel panel in a curtain wall system, the Total R-Value must be calculated in accordance with Specification 38. The Total R-Value should be calculated in accordance with AS/NZS 4859.2 for all other walls.
- J3D9, a combined wall-glazing construction DTS provision for an SOU, is also suitable for multi-class buildings as it is similar to the J4D6 (Walls and glazing) provision already used in the NCC for other building classifications.

3.2.3.4 Thermal bridging

- You can also reduce the level of thermal bridging mitigation needed by optimising other features, like the roof or wall colour. If you choose characteristics that work best in your climate to minimise the overall insulation requirement, you won't need to do as much to mitigate the thermal bridging.

3.2.3.5 Thermal bridging and thermal break requirements

- The NCC requires a thermal break with an R-Value of at least R0.2 at all points of contact between:
 - metal roof sheeting and purlins, battens or rafters where there is no ceiling, or where the ceiling lining is attached directly to those purlins, battens or rafters.
 - the metal frame and fibre-cement, weatherboard and metal-sheet cladding or the like, if the building does not have a wall lining or has a wall lining directly fixed to the frame.
- This requirement is distinct from the thermal bridging mitigation requirements and addresses localised cold/hot patches due to heat transfer from the cladding through the frame.
- Some products or construction systems can meet the thermal bridging and thermal break requirements simultaneously. For example, if a designer specifies continuous insulation between the lining and the frame, the lining is no longer fixed directly to the frame, so there is no need for an additional thermal break.
- If thermal bridging is instead addressed with extra insulation in the frames, a thermal break is still needed as the extra insulation does not prevent local cold/hot patches.

3.2.3.6 External glazing

- Solar absorptance of window frames - Darker frames conduct more heat from solar radiation and effectively increase the impact of solar gains through glazing. Darker frames improve performance in winter and decrease performance in summer.



- External shading devices (e.g. external blinds) need to block at least 80% of the incident radiation from striking the glazing.
- Window percentages - In the ABCB Glazing Calculator (available from the [ABCBC website](#)), the percentage of the total score for each window is shown. Look at the windows with the highest scores (i.e. lowest performing). Focus your improvement strategies on these windows to get the best 'value for money' improvements.
- Window orientation - The most cost-effective way to improve glazing performance is to improve window orientation. North windows in cool and mild climates and south windows in hot climates (NCC zones 1 and 3) will allow you to achieve the easiest compliance. Not all sites allow ideal glazing orientation. However, even on a poorly oriented site better design can at least minimise the glazing exposed to the worst orientations.
- Window sizes - When all the above options have been exhausted some minor reduction of window size, particularly for those windows with the highest scores, may allow further compliance cost savings. However, reducing window size will not always produce a better result as this will depend on orientation and NCC climate zone. Typically, the benefits of smaller windows are more pronounced in cooler climates and particularly for poorly oriented or shaded windows, but loss of passive solar gain on North, East and West elevations can lead to adverse impacts. In warmer climates, larger windows with improved ventilation (window 'open-ability') produce better outcomes, particularly when orientated south or are shaded.
- Window products and their thermal performance (Total U-Value and Total System SHGC) are available from the [Window Energy Rating Scheme \(WERS\)](#).

3.2.3.7 Building sealing

- Air leakage most commonly occurs at the:
 - roof/ceiling to wall junction
 - floor to wall junction
 - wall to door frame junction
 - wall to window frame junction
 - all services penetrations.
- In addition to the sealing requirements for chimneys and flues, Part G2 of NCC Volume One contains requirements that also need to be met.
- For exhaust fans, a simple flap damper system can fulfil the minimum requirements. These are readily available for most fan types. Alternatively, a mesh filter system, like those used in kitchen range hoods, is acceptable. This is because these systems significantly restrict the flow of air when the fan is not operating.



- In J4D7(2) that covers the construction of ceilings, walls and floors, the term ‘close-fitting’ is used, but what does this term mean? Since doors and windows require a compressible seal, it would not be acceptable to have visible gaps surrounding the window or door unit. Therefore, a reasonable interpretation of ‘close fitting’ could be a gap less than that between the compressible seal of a closed window or door and the associated frame.

3.2.3.8 Ceiling fans

- Ceiling fans can significantly reduce the use of artificial cooling.
- Climate zones 1, 2, and 3 benefit from ceiling fans being installed in habitable rooms, including bedrooms.
- In climate zone 5 areas of NSW (e.g. Sydney) and Qld, ceiling fans were found to similarly minimise the use of artificial cooling in habitable rooms.
- Bedrooms need fewer ceiling fans because they are typically occupied at cooler times of the day.
- Non-habitable spaces and circulation spaces are not required to have ceiling fans.

3.2.3.9 WOH energy usage

- The WOH energy usage calculations:
 - allow for variable energy load conditions throughout each day
 - are based on the total energy costs of an SOU (net sum of hourly costs for regulated energy uses for a year)
 - consider the cost savings afforded by rooftop solar PV (apportioned to an individual SOU) by accounting for the reduction in operating costs of non-regulated appliances, such as the plug loads of fridges, microwaves, computers and TVs.
- If the WOH energy use calculations did not account for non-regulated energy appliances, then the calculations would not correctly value the contribution of rooftop solar PV. This is because a greater proportion of solar generation would appear to be fed back into the grid than used in the house.
- The ABCB Standard for Whole-of-Home Efficiency Factors (2022) should be read in conjunction with the NCC and when using the ABCB Whole-of-home Calculator so the requirements are applied correctly. Part 1 of this standard covers introductory matters such as the scope and application of the standard, how it is referenced by the NCC and forms part of the DTS Provisions.
- Part 2 of the standard contains limitations and further guidance on using the standard. A limitation of the standard is that it only covers the range from 1 to 10 kW or equivalent rooftop solar PV capacity beyond this another compliance option must be used, see section 2.4 of this document.



- When using the above-mentioned Standard for gas heating and heat pump appliances, the factors must be obtained from the closest rating that can be chosen from the tables. For example, if the heating equipment is a 2-star gas ducted system, 'Gas – ducted < 3 stars' should be used, not 'Gas – ducted < 4.5 stars'.
- Other than climate zone 1, if no heating and/or cooling is specified for a dwelling, 'Other or none specified' must be selected to determine the applicable WOH efficiency factors.
- The ratings in brackets for heat pumps are values based on ratings to the GEMS pre-2019 determination for air-conditioners.
- The star rating selected for heat pumps registered under the GEMS 2019 (or later) determination should correspond to the appropriate zone on the energy rating label (hot, cold or average) for the house location. For more detail, see the [energy rating website](#).
- Careful handling on-site of rooftop solar PV is recommended due to the associated electrical risks. Users should observe the relevant instructions provided in AS/NZS 5033: Installation and safety requirements for photovoltaic arrays.
- WOH energy usage calculations using the DTS Provisions that form part of the Elemental compliance option are consistent with but provide slightly different outcomes to WOH ratings through the use of NatHERS software tools. This is because NatHERS WOH ratings use hourly calculations for a full year using the thermal rating of the SOU being modelled, whereas the WOH energy usage calculations in the DTS Provisions approximate this calculation.

3.2.3.10 Air-conditioning and ventilation systems

- Ductwork insulation needs to be protected from the effects of weather as required by clause J6D6. When conveying cool air, for the case of using a membrane for vapour barrier, the adjoining sheets need to have a minimum overlap 50 mm and bond or tapped together.
- NCC Volume Three has further information on the requirements for water heaters in a heated water supply system.

3.2.4 Demonstrating compliance

3.2.4.1 Assessment Methods for DTS Solutions

An overview of how to comply and demonstrate compliance with the NCC is outlined in Appendix C, with further guidance available from the [ABCBC website](#).

The DTS Provisions that form the Elemental compliance option are used to demonstrate NCC compliance using a DTS Solution. A2G3(2) sets out the following Assessment Methods as being suitable for demonstrating compliance for DTS Solutions:

- Evidence of suitability (NCC clauses A2G2, A2G3, A5G1 to A5G4).



- Expert Judgement (NCC clauses A2G2 and A2G3 of the NCC).

The following provides further information on these Assessment Methods.

3.2.4.2 Evidence of suitability

Evidence of suitability, also known as 'documentary evidence', can generally be used to support that a material, product, form of construction or design satisfies a DTS Provision. Subject to certain NCC provisions, the form of evidence that may be used consists of one, or a combination, of the following:

- A report from an Accredited Testing Laboratory.
- A Certificate of Conformity or a Certificate of Accreditation.
- A certificate from a professional engineer or appropriately qualified person.
- A current certificate issued by a product certification body that has been accredited by JAS-ANZ.
- Any other form of documentary evidence that adequately demonstrates suitability such as a Product Technical Statement.

More information on this Assessment Method is available in the ABCB Evidence of Suitability Handbook (2021).

In relation to residential energy efficiency, individual jurisdictions may have issued directions or notices specifying what documentary evidence is considered acceptable to demonstrate compliance.

3.2.4.3 Expert Judgment

Where physical criteria are unable to be tested, or modelled by calculation, the opinion of an expert may be accepted. Expert Judgment is the judgement of a person who has the qualifications and experience necessary to determine whether a Performance Solution or DTS Solution complies with the Performance Requirements.

It is the role of the appropriate authority to determine whether a person providing an Expert Judgment is considered an expert.

More information on the use of Expert Judgment including guidance on who may be considered an expert is in the ABCB guidance material resource, Understanding the NCC – Assessment Methods, which is available from the ABCB website.

The energy efficiency of a proposed SOU in an apartment building is readily determined by impartial methods such as evidenced-based calculations; therefore, Expert Judgment is inappropriate as a sole Assessment Method for assessing a DTS Solution for energy efficiency in an SOU of an apartment building.



3.2.5 Examples

To assist complying with the DTS Provisions that form the Elemental compliance option, several examples are in Appendix D, as follows:

- Building fabric – [Appendix D.2](#)
- Glazing – [Appendix D.3](#)
- Ceiling fans – [Appendix D.4](#)
- WOH energy usage – [Appendix D.5](#)
- Artificial lighting (part of services) – [Appendix D.6](#).



3.3 Compliance Option 3: J1V5 Verification using a reference building

3.3.1 Introduction

J1V5 Verification using a reference building (VURB) for a Class 2 SOU is a Verification Method that can be used as part of a Performance Solution to meet the energy efficiency Performance Requirements for all SOUs of an apartment building, i.e. J1P2 and J1P3.

Note that J1V5 can also be combined with J1V3 (See Section 4.4) modelling for a mixed-use building or for the common areas of an apartment building. See Appendix C for more information on how to comply with the NCC.

Compared to NCC 2019, this is a new compliance option for NCC 2022.

Reminder

A2G1 of the NCC specifies that all relevant NCC Performance Requirements need to be met to achieve compliance with the NCC. This means both J1P2 and J1P3 need to be met in full for an SOU, with no reduction or trading of performance between Performance Requirements permitted. This means J1V5 does not permit the trading of performance of an SOU between the relevant Performance Requirements J1P2 and J1P3.

Reminder

A key principle underpinning the NCC 2022 apartment energy efficiency requirements is that all compliance options aim to offer an equivalent level of performance. This principle helps ensure the policy objectives set out in Objective J1O1 (see section 2.2) are achieved.

3.3.2 Method

The intent of J1V5 is to allow for a single energy model to cover all SOUs in an apartment building. This is achieved using a computer simulation tool that is **not** a NatHERS software tool.

J1V5 VURB is a comparative method, as it assesses the heating load and/or cooling load of a theoretical reference SOU and compares it to the heating and/or cooling load of a proposed SOU. It also compares the energy value of a proposed SOUs domestic services to the set benchmark of a reference SOU. The characteristics of the reference SOU are those of an SOU modelled using certain elemental DTS Provisions contained in Volume One.

The J1V5 compliance pathway for the SOUs of an apartment building shares many similarities with J1V3. However, a key difference is that J1V5 enables the energy model to show the benefits of natural ventilation in keeping an apartment comfortable.

Figure 3.13 outlines the relevant requirements that form the J1V5 VURB compliance option. Each of these requirements is discussed in further detail in this chapter.

Figure 3.13 J1V5 VURB compliance option

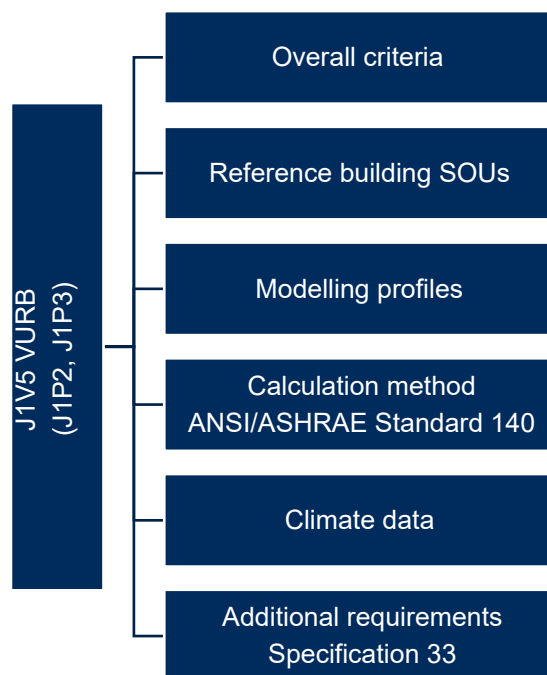

3.3.2.1 Overall criteria

J1V5(1) contains the requirements that must be met to comply with J1P2. These are summarised in Table 3.50.

Table 3.50 Overall J1V5 criteria for J1P2

Climate zone(s)	Criteria
3, 4, 5, 6,7 and 8	<ul style="list-style-type: none"> • Heating load of each SOU of the proposed building is less than or equal to both of the following: <ul style="list-style-type: none"> – a reference building – 120% of J1P2(1). • Complies with the additional requirements in Specification 33 and 45 as applicable



Climate zone(s)	Criteria
1, 2, 3, 4 and 5	<ul style="list-style-type: none"> Cooling load of each SOU of the proposed building is less than or equal to both of the following: <ul style="list-style-type: none"> a reference building 120% of J1P2(2). Complies with the additional requirements in Specification 33 and 45 as applicable

J1V5(2) contains the requirement that must be met to comply with J1P3. These are summarised in Table 3.51.

Table 3.51 Overall J1V5 criteria for J1P3 (J1V5(2)(a))

Proposed building	Reference building
<ul style="list-style-type: none"> Energy value of the domestic services³³ is less than that of a reference building J1V5(2). 	<ul style="list-style-type: none"> Benchmark for each SOU: <ul style="list-style-type: none"> A 3-star ducted heat pump (GEMS, 2019) for space heating and cooling A 5-star instantaneous gas water heater (2017 GEMS) A lighting power density of 4 w/m².

J1V5(1) and (2) contain additional requirements that need to be complied with. These include:

- Specification 45 Modelling profiles
- Specification 33 Additional requirements.

These are discussed in the following sections.

3.3.2.2 Reference building SOUs

Clause 2 of Specification 45 (S45C2) requires the heating loads and cooling loads to be calculated for the reference building SOU in accordance with the DTS clauses and requirements outlined in Table 3.52.

Table 3.52 S45C2 Reference building SOU

S45C2 reference to DTS or requirement	Element/requirement
J3D7	Roofs

³³ Includes all centralised domestic services infrastructure.



S45C2 reference to DTS or requirement	Element/requirement
J3D9	Wall-glazing construction
J3D10	Floors
J4D5	Roof lights (skylights)
S45C2(e)	Solar absorptance of 0.6 for external walls and roofs
S45C2(f)	Open area of $3.8 \times 10^{-4} \text{ m}^2$ per m^2 of zone façade area for façade air infiltration, separate to designed natural ventilation openings

3.3.2.3 Modelling profiles

S45C3 specifies the parameters used for modelling the proposed building and reference building, to ensure a fair and equal comparison of parameters between the 2 building models.

In general, the heating load, cooling load and energy value for J1V5(1) and (2) must be calculated using the same parameters for each SOU of the proposed building and reference building. Similarly, the natural ventilation modelling requires using the same parameters.

The key requirements that must be the same in both modelling runs and the associated clause reference is in Table 3.53.

Table 3.53 Key requirements for both models using J1V5 VURB

Requirements that must be the same for both models	NCC reference(s)
Heating/cooling load limits	S45C3(1)(a) Table S45C3a
Energy value factors	S45C3(1)(b) Tables S45C3b and S45C3c
Location	S45C3(1)(c) S34C3(3)
Climatic data	S45C3(1)(d) Typical Meteorological Year (TMY) weather files 1990-2015 CSIRO
Adjacent structures and features	S45C3(1)(e)
Orientation	S45C3(1)(f)



Requirements that must be the same for both models	NCC reference(s)
Building form including: <ul style="list-style-type: none"> • roof geometry • floor plan • number of stories • location • extent and configuration of ground floors and basements • the size and location of glazing • external doors • walls between or bounding SOUs and balconies. 	S45C3(1)(g)(i) to (viii)
Testing standards including for Insulation, glazing, water heater and unitary air-conditioning equipment	S45C3(1)(h)
Fabric and glazing including thermal resistance of air films and internal shading devices	S45C3(1)(i) and (ii)
System configuration and control of air-conditioning services and energy sources ³⁴	S45C3(1)(j)
Capacity and water usage	S45C3(1)(k)(i) to (v) Table A.6.2, Table A.6.3 and Table A.8 of AS/NZS 4234
Internal heating loads	S45C3(1)(l) Table S45C3d
Occupancy profiles	S45C3(1)(m) Tables S45C3e, S45C3f, S45C3g, S45C3h, S45C3i, S45C3j, S45C3k and S45C3l
Internal zoning	S45C3(1)(n)(i) to (iv)
Calculating the temperature difference across air-conditioning zone boundaries	S45C3(1)(o)
Floor coverings, furniture and fittings density	S45C3(1)(p)

³⁴ Not including renewable energy generated on-site.



Requirements that must be the same for both models	NCC reference(s)
Internal artificial lighting	S45C3(1)(q)
Heating thermostat setting for SOU and all centralised services infrastructure	S45C3(2)(a)(i) and (ii)
Cooling thermostat setting for SOU and all centralised services infrastructure	S45C3(2)(b)(i) to (vi)
Frequency of data output for natural ventilation	S45C3(3)(a)
Opening flow properties for natural ventilation	S45C3(3)(b) Table S45C3m
Wind pressure coefficients for natural ventilation	S45C3(3)(c) Tables S45C3n and S45C3o
Infiltration values for natural ventilation	S45C3(3)(d)
Operation settings for natural ventilation	S45C3(3)(e)(i) to (iii)

3.3.2.4 Calculation method

As indicated in J1V5, the calculation method used for J1V5(1) and J1V5(2) must comply with ANSI/ASHRAE Standard 140 and should not be NatHERS software. ANSI/ASHRAE Standard 140 provides a consistent test method for the evaluation of building analysis computer programs.

Alert:

ANSI/ASHRAE Standard 140 2007 is the Standard Method of test for the Evaluation of Building Energy Analysis Computer Programs. ANSI/ASHRAE Standard 140 specifies test procedures for evaluating the technical capabilities of software used to calculate the thermal performance of buildings and their HVAC systems.

3.3.2.5 Climate data

S45C3 specifies the TMY weather files drawn from the years 1990 to 2015 published by CSIRO should be used for climatic data, which were used to develop J1P2. This dataset contains 83 text files in EnergyPlus Weather File (EPW) format. The files contain hourly weather data for a typical meteorological year in 83 Australian locations. Refer to [CSIRO AgData Shop](#) (free access) for more information.



3.3.2.6 Additional requirements

In addition to the modelling requirements specified in J1V5, a building must comply with the requirements specified in S33C2. A summary of the additional requirements is shown in Table 3.54.

Table 3.54 Additional requirements from Specification 33

S33C2 reference	NCC reference/requirement
(a) General thermal construction	<ul style="list-style-type: none"> J4D3
(b) Floor edge insulation	<ul style="list-style-type: none"> J4D7(2) and J4D7(3)
(c) Building sealing	<ul style="list-style-type: none"> J1V4 or Part J5
(d) Air-conditioning and mechanical ventilation systems	Covers deactivation, control and insulation <ul style="list-style-type: none"> J6D3(1)(a), J6D3(1)(b)(i) J6D3(1)(d), J6D3(1)(f) J6D3(2) and (3) J6D4(2) and (4) J6D5, J6D6 and J6D9
(e) Packaged air-conditioning equipment	<ul style="list-style-type: none"> Applies to equipment not less than 65 kW_r AS/NZS 3823.1.2 at test condition T1
(f) Refrigeration system	<ul style="list-style-type: none"> Applies to testing a refrigeration chiller AHRI 551/591
(g) Interior artificial lighting and power control	<ul style="list-style-type: none"> J7D4
(h) Interior decorative and display lighting	<ul style="list-style-type: none"> J7D5
(i) Artificial lighting around the exterior of a building	<ul style="list-style-type: none"> J7D6
(j) Boiling water and chilled water storage units	<ul style="list-style-type: none"> J7D7
(k) Deactivation of swimming pool heating and pumping	<ul style="list-style-type: none"> J8D3(2)(b) and J8D3(3)
(l) Deactivation of spa pool heating and pumping	<ul style="list-style-type: none"> J8D4(2)(b) and J8D4(3)
(m) Facilities for energy monitoring	<ul style="list-style-type: none"> Part J9
(n) Deactivation of fixed outdoor space heating appliances	<ul style="list-style-type: none"> J6D10(3)



Alert

The J1V5 pathway for apartments shares many similarities with the J1V3 pathway for common areas in Class 2 buildings. However, J1V5 enables the energy modeller to show the benefits of natural ventilation in keeping an apartment comfortable.

Modelling of natural ventilation is complex and may be outside the experience of energy simulators who have only worked on commercial buildings, where buildings are usually fully mechanically air conditioned throughout the occupied spaces.

3.3.3 Useful tips

- In general, the heating load, cooling load and energy value for J1V5(1) and (2) must be calculated using the same parameters as outlined in S45C3(1)(a) to S45C3(1)(q) for each SOU of the proposed building and reference building. Similarly, the natural ventilation modelling requires using the same parameters as indicated in S45C3(3) for SOUs.
- For the air-conditioning services, including all centralised domestic services infrastructure, the specified heating and cooling thermostat settings (see S45C2(1)(a) and (b)) must be used for modelling SOUs of the two buildings. Note that the heating thermostat setting is identical regardless of the climate zones, while the cooling thermostat setting varies depending on the climate zones.
- For centralised hot water systems in Class 2 buildings, Verification Method J1V5 can be used to demonstrate compliance. Specification 45, which provides the modelling protocol for J1V5, includes some protocols for the calculation of heated water energy consumption.
- Central hot water system components that impact energy use include: a system to produce hot water (can include solar thermal collection panels); storage tank; pipework system; and pumps (primary and secondary) to circulate hot water. J1V5 modelling of hot water energy usage in apartment buildings with centralised hot water systems requires consideration of both the heater conversion efficiency and energy losses, such as those associated with storage, distribution (insulation, pipe diameter and length) and parasitic losses due to added pumping energy.
- For multi-classification buildings, a combined J1V3/J1V5 solution using a single energy model is possible.
- The key requirements that must be the same for both models are listed in Table 3.26. However, parameters that can be changed include the following:
 - Type of glazing - this includes the thermal performance of the glazing (Total System U-Value and Total System SHGC), ability to open and degree of shading.



- Amount of insulation.
- Types of construction materials (may affect glazing calculations).
- Timber floor or slab (may affect glazing calculations).
- Colours of external cladding.
- ANSI/ASHRAE Standard 140 can be used to identify and diagnose differences from building energy simulation software that may be caused by modelling limitations, input errors, algorithmic differences, faulty coding, or inadequate documentation.
- J1V5 requires that the reference building is set using J3D9 (Wall-glazing construction of an SOU). This requires a Total System U-Value calculation, which is used as an input into the energy model for the proposed building. This model assumes that thermal bridges are effectively mitigated when the design of the reference building façade to achieve the minimum Total system U-Value is completed. The proposed building may require thermal breaks depending on its construction type or to achieve a given U-Value.
- Through the building energy simulations of the proposed building and the reference building, a detailed model of the annual cost to run the appliances can be built up. If it is shown that the centralised system of the proposed building is cheaper to run than the benchmark appliances of the reference building, the proposed building should comply. The cost here is the “societal cost”. To help you calculate the “societal cost” based on the energy consumption, fuel type, time of use, and the state or territory where the building is located, refer to Specification 45.
- There is no allowance in the benchmark for pool and spa pumps. An apartment unit with its own pool or spa will need to improve the efficiency of its cooling and heating appliances or install more solar to make up any gap.

3.3.4 Demonstrating compliance

3.3.4.1 Background

A Performance Solution can be used in an individual situation where the desired solution meets the Performance Requirements of the NCC, but not the relevant DTS Provisions. These solutions give flexibility in achieving the outcomes required and encourage innovative design and technology use.

An overview of how to demonstrate compliance with the NCC is in Appendix C of this document, with further guidance available from the [ABCBC website](#).

J1V5 VURB is a Verification Method. This means it can be used as an Assessment Method for complying with the relevant Performance Requirements. More information on Assessment Methods is provided by the resource, Understanding the NCC – Assessment Methods, which is available from the [ABCBC website](#).



3.3.4.2 Performance Solution process

Clause A2G2(4) of the NCC mandates a process for developing Performance Solutions. This process must be followed regardless of whether the Performance Solution is simple or complex in nature.

In simple terms, the 4 steps of the Performance Solution process include:

- preparing a brief
- carrying out analysis
- evaluating results
- preparing a final report.

More information on this process is in the Performance Solution Process Guidance Document and the ABCB Performance Solution Process Handbook, which are both available from the [ABCB website](#).

3.3.4.3 Professional practice and ethics

Some state and territory legislation empowers certain practitioners to develop and/or approve Performance Solutions. Irrespective of controls about who can undertake this work, the practitioners involved have a professional responsibility for ensuring that appropriately skilled and experienced persons are engaged to develop and approve Performance Solutions.

When preparing a Performance Solution, practitioners should exercise their duties in an appropriate manner. Key principles include:

- **Acting in the public interest** - In undertaking their duties, a practitioner should exercise their discretionary powers in ways that safeguard the public interest. A practitioner's consideration of the interests of their clients and employers must not be contrary to the public interest.
- **Independence** - In performing their professional duties, a building surveyor/certifier should be objective, impartial and conduct themselves in accordance with the relevant requirements of state and territory legislation. Other practitioners should ensure any conflicts of interest are disclosed to all relevant parties.
- **Competence** - A practitioner should not undertake professional work that they are not competent to perform.

**Reminder**

A2G1 of the NCC specifies that all relevant NCC Performance Requirements need to be met to achieve compliance with the NCC. This means both J1P2 and J1P3 need to be met in full for an SOU, with no reduction or trading of performance between Performance Requirements permitted. This means J1V5 does not permit the trading of performance of an SOU between the relevant Performance Requirements J1P2 and J1P3.

Reminder

A key principle underpinning the NCC 2022 apartment energy efficiency requirements is that all compliance options aim to offer an equivalent level of performance. This principle helps ensure the policy objectives set out in Objective J1O1 (see section 2.2) are achieved.

3.3.5 Examples

To assist in understanding of how to use J1V5, a case study on the application of J1V5 will be published alongside this handbook at a later date on the ABCB website.



3.4 Compliance Option 4: J1V4 Verification of building envelope sealing

3.4.1 Introduction

J1V4 Verification of building envelope sealing is a Verification Method that can be used as part of a Performance Solution to assess if a proposed solution for an SOU of an apartment building complies with the Performance Requirement J1P1(e) for building envelope sealing, and J1P2.

Compared to NCC 2019, the main change to this compliance option for NCC 2022 is the inclusion of mechanical ventilation requirements. This is because a tightly sealed SOU requires mechanical ventilation to manage indoor moisture and air quality.

3.4.2 Method

The intent of this method is to provide a means of verifying compliance with the thermal Performance Requirements of J1P1(e) and J1P2 for building envelope sealing through practical testing.

The key requirements of this Verification Method in relation to an SOU of an apartment building are summarised in Table.3.55.

Table.3.55 Key requirements of Verification of building envelope sealing

J1V4 reference	Key requirements
(1)(a) Overall criteria for apartment buildings	<ul style="list-style-type: none"> The envelope of an apartment building must be sealed to an air permeability less than or equal to 10 m³/hr.m² at 50 Pa reference air pressure Tested using Method 1 of AS/NZS ISO 9972
(2) Additional ventilation requirements	<ul style="list-style-type: none"> When an SOU of an apartment building or a Class 4 part of a building is sealed to an air permeability less than or equal to 5 m³/hr.m² at 50 Pa reference air pressure, additional ventilation is required A mechanical ventilation system must be provided that meets the following: <ul style="list-style-type: none"> be able to be overridden supplies either continuous outdoor air or outdoor air intermittently for at least 25% of a 4-hour period



J1V4 reference	Key requirements
	<ul style="list-style-type: none">– supplies a minimum flow rate greater than or equal to the flow rate calculated using equation in J1V4(2)(a)(iii).• Solid-fuelled appliances must be ventilated with permanent openings directly to outside• Gas-fuelled appliances must be ventilated in accordance with clauses 6.4 and 6.4.5 of AS/NZS 5601.1
(3) Note	<ul style="list-style-type: none">• The volume of space for determining ventilation requirements for gas-fuelled appliances is 1 m³

Alert

AS/NZS ISO 9972 is the Australian/New Zealand standard, “Thermal performance of buildings – Determination of air permeability of buildings – Fan pressurization method”.

This standard contains requirements for testing the air permeability of buildings using the fan pressurisation method, including the apparatus, measurement procedures, expression of results and the standardised format of testing reports.

There are 3 different methods contained within the standard. However, Method 1 must be used for the purposes of Verification Method J1V4.

3.4.3 Useful tips

- Verification Method J1V4 is limited to Performance Requirement J1P1(e) for building envelope sealing and cannot verify compliance with any other components of J1P1.
- The DTS Provisions for building sealing in Part J5, can be used as guidance prior to testing commencing.
- 10m³/hr.m² at 50 Pa is broadly equivalent to 10 air changes per hour at 50 Pa when applied to dwellings such as an SOU of an apartment building. The requirement in m³/hr.m² is used because it is more practical to test and confirm the performance of the building envelope.
- Temporary envelope sealing (except for that within the testing procedure) is not appropriate, as the tested scenario must represent the final building.
- This verification testing should be planned in the program of a build, to ensure that the requirement can be demonstrated, and improvements made after testing if required.



- Air infiltration rates are determined for all windows tested to AS 2047 and are published on the [WERS](#) website. The selection of windows with a low air infiltration rate should be considered to assist complying with the criteria in Verification Method J1V4.
- Method 1 within AS/NZS ISO 9972 precisely defines the testing requirements, so refer to the standard to confirm the requirements for your specific project.
- When designing a building, both Performance Solutions and DTS Solutions can be used to achieve compliance with the Performance Requirements. A combination of both Performance and DTS Solutions may also be used to satisfy a single Performance Requirement. This may include occasions where a specific Performance Requirement covers several elements of a building. This is the case for Performance Requirement J1P2 for the thermal performance of an SOU of an apartment building. Therefore, it is possible to use the J1V4 Verification Method that covers building sealing in a combination with the DTS Provisions that form part of the Elemental compliance option for the remainder of the building elements for an SOU of an apartment building. See Part A2 of NCC Volume One for more information.

3.4.4 Demonstrating compliance

3.4.4.1 Background

A Performance Solution can be used in an individual situation where the desired solution meets the Performance Requirements of the NCC, but not the relevant DTS Provisions. These solutions are often flexible in achieving the outcomes required and encourage innovative design and technology use.

An overview of how to demonstrate compliance with the NCC is in Appendix C of this document, with further guidance available from the [ABCBC website](#).

Verification of building envelope sealing is a Verification Method; therefore, where a Performance Solution utilises Verification of building envelope sealing, Verification Method is the relevant Assessment Method. More information on Assessment Methods is provided in the resource, Understanding the NCC – Assessment Methods, which is available from the [ABCBC website](#).

3.4.4.2 Performance Solution process

To help ensure a Performance Solution provides the level of intended performance, Clause A2G2(4) of the NCC mandates a process for developing Performance Solutions. This process must be followed regardless of whether the Performance Solution is simple or complex in nature.

In simple terms, the 4 steps of the Performance Solution process include:

- (1) preparing a brief
- (2) carrying out analysis



- (3) evaluating results
- (4) preparing a final report.

More information on this process is in the Performance Solution Process Guidance Document and the ABCB Performance Solution Process Handbook, which are available from the [ABCB website](#).

3.4.4.3 Professional practice and ethics

Some state and territory legislation empowers certain practitioners to develop and/or approve Performance Solutions. Irrespective of controls about who can undertake this process, the practitioners involved have a professional responsibility for ensuring that appropriately skilled and experienced persons are engaged and participate as stakeholders in the process.

When preparing a Performance Solution, practitioners should exercise their duties in an appropriate manner. Key principles include:

- Acting in the public interest - In undertaking their duties, a practitioner should exercise their discretionary powers in ways that safeguard the public interest. A practitioner's consideration of the interests of their clients and employers must not be contrary to the public interest.
- Independence - In performing their professional duties, a building surveyor/certifier should be objective, impartial and conduct themselves in accordance with the relevant requirements of state and territory legislation. Other practitioners should ensure any conflicts of interest are disclosed to all relevant parties.
- Competence - A practitioner should not undertake professional work that they are not competent to perform.

3.4.5 Example

To assist with the use of J1V4 Verification of building envelope sealing, an example is in Appendix D.7.



3.5 Compliance Option 5: Other Performance Solutions

3.5.1 Introduction

As outlined in Chapter 2, there are 3 options available to demonstrate compliance with the Performance Requirements:

- a Performance Solution
- a DTS Solution, or
- a combination of a Performance Solution and a DTS Solution.

An overview of how to comply with the NCC is in Appendix C of this document, with further guidance available from the [ABCB website](#).

A Performance Solution can be used in an individual situation where the desired solution meets the Performance Requirements of the NCC, but not the relevant DTS Provisions. These solutions are often flexible in achieving the outcomes required and encourage innovative design and technology use.

A proposed Performance Solution for an SOU needs to comply with both the relevant energy efficiency Performance Requirements J1P2 and J1P3. Any proposed Performance Solution needs to demonstrate this has been achieved.

This section outlines some potential options for Performance Solutions that do not use an NCC Verification Method as the Assessment Method.

Reminder

A2G1 of the NCC specifies that all relevant NCC Performance Requirements need to be met to achieve compliance with the NCC. This means both J1P2 and J1P3 need to be met in full for an SOU, with no reduction or trading of performance between Performance Requirements permitted.

3.5.2 Assessment Methods

Assessment Methods are used when determining if a Performance Solution complies with the relevant Performance Requirements.

The following Assessment Methods are listed in the NCC (see A2G2 and A2G3) and each, or any combination, can be used to demonstrate compliance for a Performance Solution where appropriate:

- Evidence of suitability



- Expert Judgement
- Comparison with the DTS Provisions
- Verification Methods.

Each of these Assessment Methods is discussed in the following sections.

3.5.2.1 Evidence of suitability

Evidence of suitability, also known as 'documentary evidence', can generally be used to support that a material, product, form of construction or design satisfies a Performance Requirement. Subject to certain NCC provisions, the form of evidence that may be used consists of one, or a combination, of the following:

- A report from an Accredited Testing Laboratory
- A Certificate of Conformity or a Certificate of Accreditation
- A certificate from a professional engineer or appropriately qualified person
- A current certificate issued by a product certification body that has been accredited by the JAS-ANZ
- Any other form of documentary evidence that adequately demonstrates suitability such as a Product Technical Statement.

More information on this Assessment Method is available in the [ABCBC Evidence of Suitability Handbook \(2021\)](#).

In relation to the apartment energy efficiency provisions in the NCC, individual jurisdictions may have issued specific directions, or notices specifying what documentary evidence is considered acceptable to demonstrate compliance.

3.5.2.2 Expert Judgement

Where physical criteria is unable to be tested, or modelled by calculation, the opinion of an expert may be accepted. Expert Judgment is the judgement of a person who has the qualifications and experience necessary to determine whether a Performance Solution complies with the Performance Requirements.

It is the role of the appropriate authority to determine whether a person providing an Expert Judgement is considered an expert.

More information on the use of Expert Judgement, including guidance on who may be considered an expert, is in the resource Understanding the NCC – Assessment Methods, which is available from the [ABCBC website](#).

The energy efficiency of an SOU design is readily determined by verifiable means; therefore, Expert Judgement is inappropriate as a sole Assessment Method for assessing a Performance Solution for compliance with J1P2 and J1P3.



3.5.2.3 Comparison with the DTS Provisions

This Assessment Method involves a comparative analysis demonstrating that a Performance Solution is better than, or at least equivalent to, a solution that complies with the relevant DTS Provision(s).

To carry out this comparison, the applicable DTS Solution and Performance Solution both need to be subject to the same level of analysis using the same methodology. This provides the building designer and appropriate authority with a defined benchmark or level for the DTS Solution and the Performance Solution.

The intent of J1V5 Verification using a reference building is to provide a pathway that utilises the principle underpinning the Comparison with the DTS Provisions Assessment Method, in that the outcome must be better than, or at least equivalent to, a DTS Solution. This is achieved using a reference SOU (apartment) and a proposed SOU (apartment). The method provides a set of reasonable assumptions, parameters and exclusions to help ensure a Performance Solution produced using this Verification Method provides the intended level of performance.

Therefore, it is expected that a Performance Solution that uses a Comparison with the DTS Provisions Assessment Method would use a similar set of reasonable assumptions, parameters and exclusions (such as not permitting use of NatHERS software tools) to those specified in J1V5. The parameters, assumptions, exclusions, calculation methodology and acceptance criteria would also need to be agreed by relevant stakeholders as required by the Performance Solution Process.

Reminder

A key principle underpinning the NCC 2022 apartment energy efficiency requirements is that all compliance options aim to offer an equivalent level of performance. This principle helps ensure the policy objectives set out in Objective J1O1 (see section 2.2) are achieved.

3.5.2.4 Verification Methods

Verification Methods are tests or calculations that prescribe a way to assess compliance with relevant NCC Performance Requirements. They include a test, inspection, calculation, or a combination of these.

Verification Methods not contained in the NCC may be used if deemed suitable by the appropriate authority.



3.5.3 Performance Solution Process

To help ensure a Performance Solution provides the level of intended performance, clause A2G2(4) of the NCC mandates a process for developing Performance Solutions. This process must be followed regardless of whether the Performance Solution is simple or complex in nature.

In simple terms, the 4 steps of the Performance Solution process include:

- (1) preparing a brief
- (2) carrying out analysis
- (3) evaluating results
- (4) preparing a final report.

More information on this process is in the Performance Solution Process Guidance Document and the ABCBC Performance Solution Process Handbook, which are available from the [ABCBC website](#).

3.5.3.1 Quantified Performance Requirements

For step 1 of the Performance Solution process, a performance-based design brief (PBDB) needs to be developed. The purpose of the brief is to record the fundamental activities and outcomes of the Performance Solution development, as agreed by stakeholders. The PBDB must include the acceptance criteria for the proposed Performance Solution, which often requires accounting for the location and characteristics of the building.

For NCC 2022, J1P2 is quantified while J1P3 is partially quantified. This means both Performance Requirements contain measurable benchmarks that should be used in the acceptance criteria for a PBDB for apartment energy efficiency.

J1P2 specifies load limits in Specification 44 of NCC 2022 Volume One. These limits vary based on climate factors and apply to each space. By defining the load limits based on climate factors, load limits can be determined for any home in any climate (and associated energy modelling climate file).

The quantified heating load limits and cooling load limits in J1P2 were developed with reference to the heating and cooling load limits that were introduced in 2019 as part of the DTS Provisions that form the NatHERS compliance option. The limits have been generalised for broader use in the J1P2 Performance Requirement and adjusted to reflect the stringency increase from NCC 2019 to NCC 2022. J1P2 allows for higher heating loads in cold locations, and higher cooling loads in hot, humid locations.

3.5.4 Professional practice and ethics

Some state and territory legislation empowers certain practitioners to develop and/or approve Performance Solutions. Irrespective of controls about who can undertake this work, the



practitioners involved have a professional responsibility for ensuring that appropriately skilled and experienced persons are engaged to develop and approve Performance Solutions.

When preparing a Performance Solution, practitioners should exercise their duties in an appropriate manner. Key principles include:

- **Acting in the public interest** - In undertaking their duties, a practitioner should exercise their discretionary powers in ways that safeguard the public interest. A practitioner's consideration of the interests of their clients and employers must not be contrary to the public interest.
- **Independence** - In performing their professional duties, a building surveyor/certifier should be objective, impartial and conduct themselves in accordance with the relevant requirements of state and territory legislation. Other practitioners should ensure any conflicts of interest are disclosed to all relevant parties.
- **Competence** - A practitioner should not undertake professional work that they are not competent to perform.



4 Compliance options for common areas (J1P1 and J1P4)

4.1 Compliance Option 1: Elemental

4.1.1 Introduction

The Elemental provisions compliance option is a set of DTS Provisions that can be used to meet the relevant energy efficiency Performance Requirements that apply to the common areas of an apartment building: J1P1 Energy use and J1P4 Renewable energy and electric vehicle charging.

Compared to NCC 2019, J1P4 is a new Performance Requirement and covers renewable readiness generally. A building must have features that facilitate the future installation of on-site renewable energy generation and storage and electric vehicle (EV) charging equipment.

The DTS Provisions that form the Elemental provisions compliance option are used to demonstrate NCC compliance using a DTS Solution. See Appendix C for more information on how to comply with the NCC.

4.1.2 Method

The intent of this method is to provide a step-by-step approach to comply with the energy efficiency Performance Requirements that apply to the common areas of apartment buildings. To do this, the method requires each element to meet a minimum level of thermal performance or energy use, for example, the floors, walls, glazing, roof, ceiling, air-conditioning and mechanical ventilation systems.

The elemental DTS Provisions when followed in their entirety form a DTS Solution, i.e. they are deemed to meet the energy efficiency Performance Requirements that apply to the common areas of an apartment building.

Figure 4.1 outlines the relevant DTS Provisions that form the Elemental compliance option. The DTS Provisions are in Parts J4 to J9.

Figure 4.1 Elemental DTS for the common areas of an apartment building

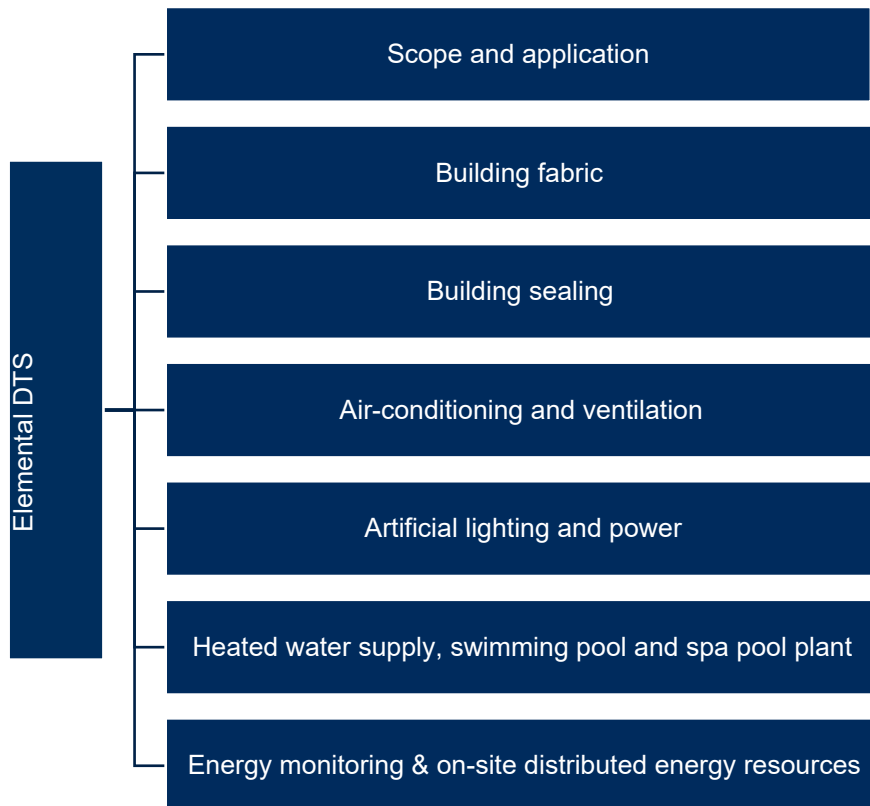

4.1.2.1 Scope and application

J2D2(1) and J2D2(4) specify the scope and application of the elemental provisions to apartment buildings.

For the common areas in an apartment building, this compliance option is located in the DTS Provisions of Volume One Part J2 and Parts J4 to J9.

To achieve the intended outcome, the DTS Provisions must be applied in accordance with:

- (1) The Governing Requirements
- (2) Any state and territory variations, additions and deletions.

4.1.2.2 Building fabric

Part J4 Building fabric contains the relevant DTS Provisions for the minimum thermal performance of the building envelope for common areas in apartment buildings. Part J4 has 6 clauses as shown in Table 4.1. These are discussed in the following sections.



Table 4.1 Building fabric clauses

Building element	Clause reference
Application	J4D2
Thermal construction	J4D3
Roofs and ceilings	J4D4
Roof lights	J4D5
Walls and glazing	J4D6
Floors	J4D7

Application

The DTS Provisions of Part J4 apply to building elements forming the envelope of an apartment building, except for J4D3(5), J4D4, J4D5, J4D6 and J4D7 which do not apply to an SOU of an apartment building. These exceptions are for building fabric elements of a common area that form part of the envelope.

Reminder

Envelope is a defined term in the NCC. As described in Schedule 1 Definitions, for the purposes of Section J in NCC Volume One, envelope means the parts of a building's fabric that separate a conditioned space or habitable room from either:

- the exterior of the building, or
- a non-conditioned space.

A non-conditioned space includes the:

- floor of a rooftop plant room, lift-machine room or the like
- floor above a carpark or warehouse
- common wall with a carpark, warehouse or the like.

Thermal construction

Clause J4D3 specifies the general requirements for thermal construction. These requirements aim to ensure that when insulation, either bulk or reflective is installed, it:

- performs thermally as intended, and
- does not interfere with the safety or performance of plumbing or electrical components.

Table 4.2 summarises the key requirements of J4D3.



Table 4.2 Key requirements for the thermal construction

Clause J4D3 reference	Key requirements
(1) Insulation	<ul style="list-style-type: none">• Where required, insulation must comply with AS 4859.1 and be installed so that it:<ul style="list-style-type: none">– abuts or overlaps to adjoining insulation, other than where other elements prevent it from doing so, such as studs or furring channels– forms continuous barrier with ceilings, walls, bulkheads floors or the like– does not affect the safe effective operation of a service or fitting.
(2) Reflective insulation	<ul style="list-style-type: none">• When required, reflective insulation must be installed with:<ul style="list-style-type: none">– the necessary airspace to achieve the required R-value between the reflective side of the insulation and a building lining or cladding– the reflective insulation closely fitted to any penetration, door or window opening– adequate support from framing members– an overlap of 50mm or taped together.
(3) Bulk insulation	<ul style="list-style-type: none">• Required bulk insulation must be installed:<ul style="list-style-type: none">– so that it maintains position and thickness, other where compressed between cladding and supporting member or services within the wall– when in a ceiling, where there is no insulation in the wall beneath, to overlap the wall by 50mm
(4) Roof, ceiling and wall materials	<ul style="list-style-type: none">• Specification 36 outlines the thermal properties of roof, ceiling and wall materials
(5) Thermal bridging	<ul style="list-style-type: none">• Required Total R-Value and Total System U-Value must be:<ul style="list-style-type: none">– calculated in accordance with AS4859.2 for roof and floor– determined using Specification 37 for wall-glazing construction



Clause J4D3 reference	Key requirements
	<ul style="list-style-type: none"> – determined using Specification 39 or Section 3.5 of the CIBSE (Chartered Institution of Building Services Engineers) Guide A for soil or sub-floor spaces.

Roofs and ceilings

The minimum thermal requirements for roof and ceiling construction are specified in clause J4D4. Clause J4D4 specifies the Total R-Value for the roof and ceiling insulation based on climate zones and the direction of heat flow, these are summarised in Table 4.3.

Table 4.3 Key requirements for roof and ceilings

Clause J4D4 reference	Roof and ceiling requirements
(1) Total R-Value	<ul style="list-style-type: none"> • Provides the Total R-Value for the different climate zones <ul style="list-style-type: none"> – R3.7, in the downward direction, for climate zones 1 to 5 – R3.2, in the downward direction, for climate zone 6 – R3.7, in the upward direction, for climate zone 7 – R4.8, in the upward direction, for climate zone 8
(2) Solar absorptance	<ul style="list-style-type: none"> • Specifies that in climate zones 1 to 7 the upper surface of a roof must have a solar absorptance less than 0.45

Reminder

Section F of NCC Volume One may require ventilation of roof space in climate zones 6, 7 and 8 to manage risks associated with condensation.

Roof lights

The requirements for roof lights (skylights) are specified in J4D5, as shown in Table 4.4.

Table 4.4 Key requirements for skylights

J4D5 reference	Key requirements
(a) Maximum area	<ul style="list-style-type: none"> • Less than or equal to 5% of the floor area of the room or space the roof light serves
(b) Thermal performance	<ul style="list-style-type: none"> • Transparent and translucent elements of roof lights:

J4D5 reference	Key requirements
	<ul style="list-style-type: none"> – achieve Total System SHGC in Table 13.2.4 – maximum Total System U-Value of U3.9 – requires calculation of roof light shaft index (See Figure 4.2)

Figure 4.2 Determining the roof light shaft index

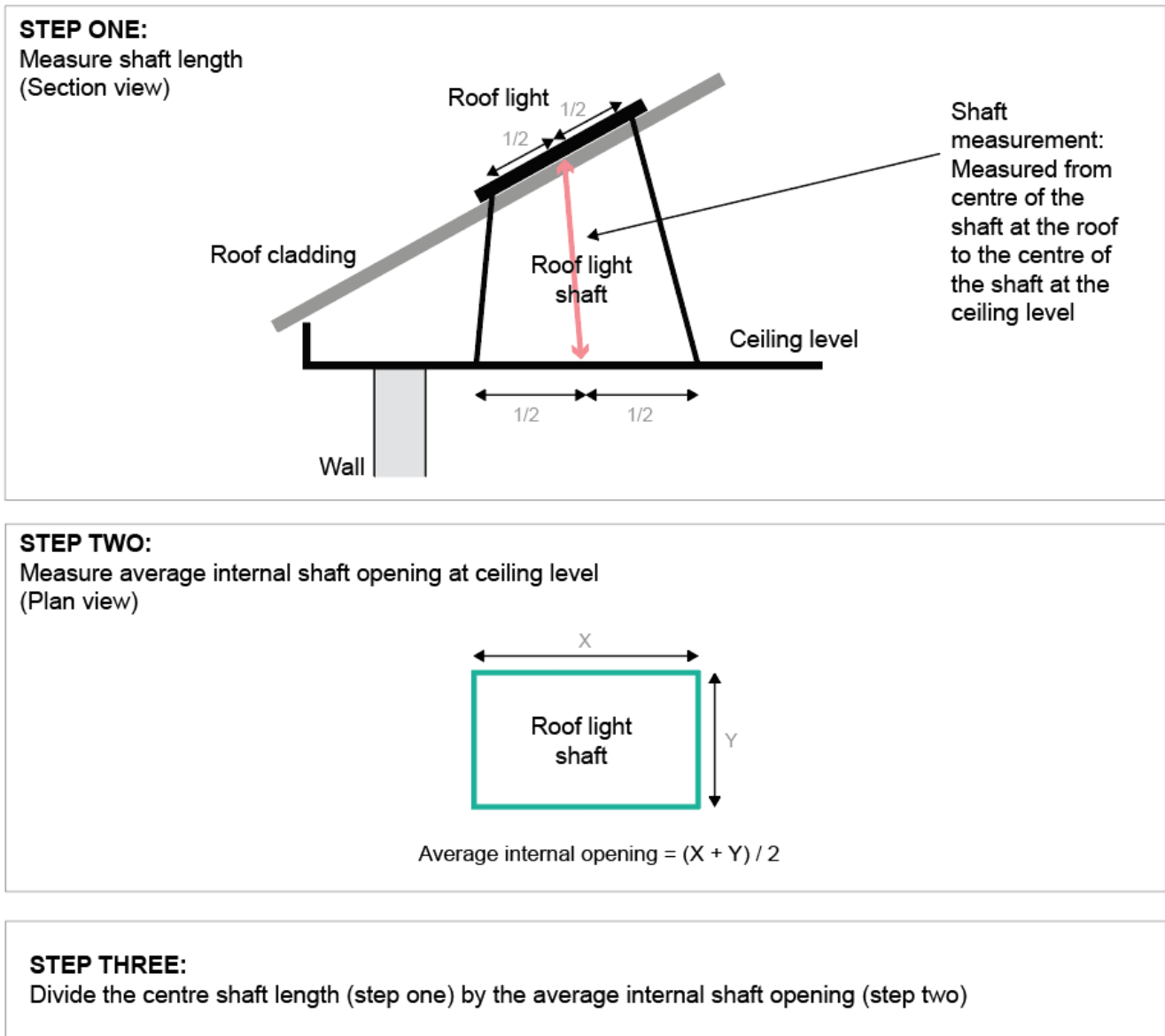

Walls and glazing

The requirements for walls and glazing are specified in J4D6, as shown in Table 4.5. This clause specifies the Total System U-Value of wall-glazing construction, based on climate zone.



Table 4.5 Key requirements for walls and glazing

J4D6 Walls and glazing	Key requirements
(1) and (3) Total System U-Value	<ul style="list-style-type: none"> Applies to wall-glazing construction, this includes wall-glazing construction which wholly or partly forms the envelope internally. Must not be greater than U2.0 Must be calculated in accordance with Specification 37
(4) Wall components	<ul style="list-style-type: none"> Applies to wall components of wall-glazing construction Must achieve a minimum Total R-Value— <ul style="list-style-type: none"> of R1.0 when the wall is less than 80% of the area of the wall-glazing construction, or specified in Table J4D6a when the wall is 80% or more of the area of the wall-glazing construction.
(5) and (6) Solar admittance	<ul style="list-style-type: none"> Applies to externally facing wall-glazing construction Excludes wall-glazing construction that is wholly internal SA must not be greater than the values specified in Table J4D6b Must be calculated in accordance with Specification 37
(2) and (7) Display glazing	<ul style="list-style-type: none"> Applies to display glazing Total System U-Value must not be greater than U5.8. Total system SHGC must not be greater than 0.81 divided by the applicable shading factor specified in S37C7.

Floors

Clause J4D7 specifies the Total R-Value and insulation requirements for floors. A summary of the key requirements of these subclauses is in Table 4.6.

Table 4.6 Key requirements for floors

J4D7 reference	Key requirements
(1) Total R-Value	<ul style="list-style-type: none"> Must achieve the Total R-Value specified in Table J4D7
(2) Total R-Value for a slab-on-ground	<ul style="list-style-type: none"> A slab-on-ground that does not have an in-slab heating or cooling system is considered to achieve a Total R-Value of R2.0, except: <ul style="list-style-type: none"> in climate zone 8



J4D7 reference	Key requirements
	<ul style="list-style-type: none"> – a Class 3 and some Class 9 buildings in climate zone 7 that has a floor area to floor perimeter ratio of less than or equal to 2.
(3) Vertical edge insulation installation and properties	<ul style="list-style-type: none"> • A floor must be insulated around the vertical edge of its perimeter with insulation having an R-Value of at least 1.0 when the floor: <ul style="list-style-type: none"> – is a concrete slab-on-ground in climate zone 8, or – has an in-slab or in-screed heating or cooling system, except where used solely in a bathroom, amenity area or the like.
(4) Water resistance and depth of insulation	<ul style="list-style-type: none"> • Insulation required by (3) for a concrete slab-on-ground must be water resistant and be continuous from the adjacent finished ground level: <ul style="list-style-type: none"> – to a depth of at least 300mm, or – for the full depth of the vertical edge of the concrete slab-on-ground.

4.1.2.3 Building sealing

Part J5 Building sealing in Volume One contains the relevant DTS Provisions to adequately seal parts of a building. The intent is to restrict air infiltration and air exfiltration.³⁵ Unintended leakage can lead to greater heat losses or gain and therefore reduced thermal comfort of occupants and consequently, increase the use of artificial heating and/or cooling.

Relevant clauses on building sealing are outlined in Table 4.7 and discussed in the following sections.

Table 4.7 Building sealing clauses

Building element	Clause reference
Application	J5D2
Chimneys and flues	J5D3
Roof lights	J5D4

³⁵ See the terms 'air infiltration and 'air exfiltration' in the Glossary at Appendix B for more information.



Building element	Clause reference
Windows and doors	J5D5
Exhaust fans	J5D6
Construction of ceilings, walls and floors	J5D7
Evaporative coolers	J5D8

Application of Part

Clause J5D2 specifies the DTS Provisions for building sealing, which apply to the elements forming the envelope of an apartment building.

There are 3 exemptions:

A building in climate zones 1, 2, 3 and 5 where the only means of air-conditioning is by using an evaporative cooler.

A permanent building opening, in a space where a gas appliance is located, that is necessary for the safe operation of a gas appliance.

A building or space where the mechanical ventilation required by Part F6 provides sufficient pressurisation to prevent infiltration.

Alert

Appropriate ventilation requirements for gas appliances can be obtained from relevant state and territory legislation, referenced standards and product installation manuals.

Chimneys and flues

Clause J5D3 requires a solid-fuel burning appliance (e.g. wood fireplace) to have a damper or flap on its chimney or flue so that it can be closed. The intent of this requirement is to prevent conditioned air being drawn up the chimney or flue when the appliance is not in use.

Roof lights

Clause J5D4 provides the minimum sealing requirements for roof lights (skylights). The skylight sealing requirements consist of 2 subclauses. The key requirements of these subclauses are summarised in Table 4.8.

Table 4.8 Key requirements to seal skylights

Clause J5D4 reference	Key requirements
(1) Application	<ul style="list-style-type: none"> Skylights must be sealed, or capable of being sealed in the following locations:



Clause J5D4 reference	Key requirements
	<ul style="list-style-type: none">– a conditioned space.– a habitable room in climate zones 4, 5, 6, 7 and 8.
(2) Sealing requirements	<ul style="list-style-type: none">• Sealing can be achieved by any of the following:<ul style="list-style-type: none">– a ceiling diffuser (no holes).– a weatherproof seal.– a manual, mechanical or electronic shutter system.

Windows and doors

Clause J5D5 provides the minimum sealing requirements for windows and doors. The requirements consist of 2 subclauses. The key requirements are summarised in Table 4.9.

Table 4.9 Key requirements to seal windows and doors

Clause J5D5 reference	Key requirements
(1) Application	<ul style="list-style-type: none">• Applies to the following doors, openable windows and similar openings:<ul style="list-style-type: none">– when they form part of the envelope– are in climate zones 4, 5, 6, 7 or 8.
(2) Sealing requirements	<ul style="list-style-type: none">• A draft protection device must be used to seal the bottom edge of a door.• A foam or rubber compressible strip, or fibrous seal, must be used to seal the other edge of doors and openable windows.
(3) Exemption	<ul style="list-style-type: none">• A windows that comply with AS 2047.• Fire doors or smoke doors.• Roller shutter doors, roller shutter grille or other security doors or devices.

Exhaust fans

Clause J5D6 sets out the requirements for exhaust fans. Exhaust fans must be sealed with a self-closing damper or filter when located in one of the following:

- A conditioned space.
- A habitable room in climate zones 4, 5, 6, 7 or 8.



Construction of ceilings, walls and floors

Clause J5D7 provides the minimum requirements for sealing ceilings, walls and floors at junctions and around window and door penetrations. The requirements consist of 2 subclauses. A summary of the key requirements is outlined in Table 4.10.

Table 4.10 Key construction requirements to seal ceilings, walls and floors

Clause J5D7 reference	Key requirements
(1) Application	<ul style="list-style-type: none"> • Applies to the following components of the envelope: <ul style="list-style-type: none"> – ceilings – floors – window frames – door frames – skylight frames. • Seals are needed for climate zones 4, 5, 6, 7 or 8.
(2) Construction requirements	<ul style="list-style-type: none"> • Option 1: Construction in (1) must be enclosed by internal lining systems that are close-fitting for the following construction elements: <ul style="list-style-type: none"> – ceilings – walls and floor junctions. • Option 2: Construction in (1) must be sealed at junctions and penetrations by either of the following: <ul style="list-style-type: none"> – close-fitting architraves, skirting or cornices – expanding foam, rubber compressive strip or caulking.
(3) Exemption	<ul style="list-style-type: none"> • Openings, grilles or the like required for smoke hazard management.

Evaporative coolers

Clause J5D8 provides the minimum requirements for sealing evaporative coolers. Evaporative coolers must be sealed with a self-closing damper when supplying a heated space, or located in climate zone 4, 5, 6, 7 or 8.

4.1.2.4 Air-conditioning and ventilation

Part J6 sets out the provisions for the efficiency and control of air-conditioning and ventilation.



This includes air-conditioning, space heating and ventilation equipment, the efficiency, sealing and insulation requirements for ductwork systems containing fans, and for the efficiency and insulation of pipework and pump systems.

The relevant J6 clauses for different services are outlined in Table 4.11.

Table 4.11 Air-conditioning and ventilation clauses

Service	Clause reference
Application	J6D2
Air-conditioning system control	J6D3
Mechanical ventilation system control	J6D4
Fans and duct systems	J6D5
Ductwork insulation	J6D6
Ductwork sealings	J6D7
Pump systems	J6D8
Pipework insulation	J6D9
Space heating	J6D10
Unitary air-conditioning equipment	J6D12

Note to Table 4.11: These clauses generally apply to an apartment building except for some clauses where they do not apply if there is only one SOU.

Application

The DTS Provisions for air-conditioning and ventilation specified in Part J6 cover several building classifications including an SOU in an apartment building.

Air-conditioning system control

The requirements for air-conditioning system control are provided in Clause J6D3. These are outlined in Table 4.12.

Table 4.12 Key requirements for air-conditioning system control

J6D3 reference	Key requirements
(1) An air-conditioning system.	<ul style="list-style-type: none"> Must be capable of being deactivated when the building or part of the building served by that system is not occupied. When serving more than one air-conditioning zone or area with different heating or cooling needs, must:



J6D3 reference	Key requirements
	<ul style="list-style-type: none">– thermostatically control the temperature of each zone or area– not control the temperature by mixing actively heated/cooled air– limit reheating to not more than a 7.5K rise in temperature at a fixed supply air rate as well as at the nominal supply air rate for a variable supply air rate.• Possess an outdoor air economy cycle function according to Table J6D3.• Capable of stopping the flow of water to those not operating.• With an airflow of more than 1000 L/s, must have a variable speed fan when its supply air quantity is capable of being varied.• Use direct signals to regulate the operation of central plant.• A control dead band of not less than 2°C in general.• Provided with balancing dampers and balancing valves to ensure achieving the maximum design air/fluid flow, but not exceeded by more than 15% for each component or group of components.• Automatic variable temperature operation of heated water and chilled water circuits.• Close any motorised outdoor air or return air damper that is not otherwise being actively controlled.
(2) Two or more air-conditioning systems.	<ul style="list-style-type: none">• Control sequences must be used when two or more air-conditioning systems serve the same space.
(3) Time switches.	<ul style="list-style-type: none">• Time switches must be provided as follows.<ul style="list-style-type: none">– When controlling an air-conditioning system of more than 2 kW_r and a heater of more than 1 kW_{heating}.– Be capable of switching electric power on and off at variable pre-programmed times and on variable pre-programmed days.• The above requirements do not apply to:



J6D3 reference	Key requirements
	<ul style="list-style-type: none"> – an air-conditioning system that serves only one SOU in an apartment building – a conditioned space where air-conditioning is needed for 24 hour continuous use.

Mechanical ventilation system control

Clause J6D4 specifies the requirements for mechanical ventilation system control. Table 4.13 outlines the key requirements for J6D4.

Table 4.13 Key requirements for mechanical ventilation systems

J6D4 reference	Key requirements
(1) General	<ul style="list-style-type: none"> • Specifies requirements for mechanical ventilation system control, except for systems which serve a single SOU in an apartment building or a Class 4 part of a building. • Be capable of being deactivated when the building or part of the building it serves is unoccupied. • When serving a conditioned space, except when an evaporative cooler is in use: <ul style="list-style-type: none"> – Have energy reclaiming systems for systems specified in J6D4 – Demand control ventilation as per AS 1668.2 for systems specified in J6D4. • Not exceed minimum outdoor air requirements of F6 except <ul style="list-style-type: none"> – Free cooling of the system is supplied by additional unconditioned outdoor air – The required exhaust or process exhaust needs additional mechanical ventilation – Outdoor air is preconditioned by an energy reclaiming system. • Have a variable speed fan for systems with an airflow of 1000 L/s or more, except if downstream airflow is required by Part F6
(2) Exhaust systems	<ul style="list-style-type: none"> • Not applicable to exhaust systems in an SOU of an apartment building
(3) Carpark exhaust systems	<ul style="list-style-type: none"> • Not applicable to exhaust systems in an SOU of an apartment building



(4) Time switches	<ul style="list-style-type: none"> • Be provided to mechanical ventilation systems with an air flow for 100 L/s or more • Be capable of switching electric power on or off at variable pre-programmed times and on variable pre-programmed days • Exemptions: <ul style="list-style-type: none"> – Mechanical ventilation system that serves a single SOU in a Class 2 building – A Class 4 part of a building – Where mechanical ventilation is needed for 24 hour occupation
-------------------	---

Fans and duct systems

Clause J6D5 sets out requirements for fans, ductwork and duct components used as part of an air-conditioning system or mechanical ventilation system. The key requirements for J6D5 are in Table 4.14.

Table 4.14 Key requirements for fan and duct systems

J6D5 reference	Key requirements
(1) Application	<ul style="list-style-type: none"> • Fans, ductwork and ducts in an air-conditioning or mechanical ventilation system must: <ul style="list-style-type: none"> – Option1 - separately comply with the requirements for fans, ductwork and ducts – Option 2 – achieve a fan motor input power per unit of flowrate lower than the fan motor input power per unit of flowrate of (2) – (5) combined.
(2) Fans	<ul style="list-style-type: none"> • Fans must have a minimum efficiency at full load calculated as outlined in J6D5(2). • J6D5(2) has separate calculation methods for systems with static pressure of 200 Pa or less, and above 200 Pa.



J6D5 reference	Key requirements
(3) Ductwork	<ul style="list-style-type: none">• Pressure drop in the index run must not exceed 1 pa/m³⁶• Flexible ductwork must not be more than 6m in any duct run• Bends, elbows and tees must have an equivalent diameter to the duct they are connected to• Turning vanes to be included in all rigid ductwork elbows of 90° or less except:<ul style="list-style-type: none">– when their inclusion presents a fouling risk– a long radius bend in accordance with AS 4254.2 Ductwork for air-handling systems in buildings – Rigid duct, is used.
(4) Ductwork components	<ul style="list-style-type: none">• Set outs requirements for ductwork components in the index run and cover the following:<ul style="list-style-type: none">– pressure drop across coils– high efficiency particulate arrestance (HEPA) air filters– other air filters– intake louvres– variable air volume boxes– rooftop cowls– attenuators– fire dampers– balancing and control dampers– supply air diffusers– exhaust grilles– transfer ducts– door grilles– active chilled beams.

³⁶ Averaged over the entire length of duct. The pressure drop of flexible ductwork sections may be calculated as if flexible ductwork is laid straight.



J6D5 reference	Key requirements
(5) Exemptions	<ul style="list-style-type: none"> • The requirements of (1) to (4) don't apply to: <ul style="list-style-type: none"> – fans in unducted air-conditioning systems with a capacity of less than 1000 L/s – smoke spill fans – the power for process-related components – kitchen exhausts.

Note to Table 4.14: Application of J6D5 (1) to (4) to an SOU in an apartment building are dependent on the design of the air-conditioning system.

Ductwork insulation

J6D6 sets out the requirements to reduce energy loss, ductwork and fittings in an air-conditioning system need to be insulated. The key requirements for J6D6 can be found in Table 4.15.

Table 4.15 Key requirements for ductwork insulation

J6D6 reference	Key requirement
(1) Application	<ul style="list-style-type: none"> • Specifies that insulation for ductwork and fittings for air-conditioning systems must: <ul style="list-style-type: none"> – comply with AS 4859.1 Thermal insulation materials for building – General criteria and technical provisions – have a minimum insulation R-Value of: <ul style="list-style-type: none"> ○ R1.0 for flexible ductwork, or ○ for cushion boxes equivalent to connecting ductwork, or ○ comply with Table J6D6.
(2) Installation of ductwork insulation	<ul style="list-style-type: none"> • Insulation must: <ul style="list-style-type: none"> – be protected from the weather – abut adjacent insulation to form continuous layer – maintain its thickness other than at flanges or supports – be protected by a vapor barrier on the outside of the insulation when conveying cool air. The vapour barrier must be installed so that adjacent layers overlap by 50mm and are bonded or taped together



(3) Exemptions	<ul style="list-style-type: none"> • The requirements of (1) do not apply to: <ul style="list-style-type: none"> – ductwork and fittings located in the only or last room served by the system – fittings that form part of the interface with the conditioned space – return air ductwork which are in, or passing through a conditioned space – ductwork for outdoor air and exhaust air associated with an air-conditioning system – the floor of an in-situ air-handling unit – packaged air conditioners, split systems and variable refrigerant flow air-conditioning equipment complying with Minimum Energy Performance Standards (MEPS) – flexible fan connectors.
(4) Fittings	<ul style="list-style-type: none"> • Include non-active components of a ductwork system such as cushion boxes • Exclude active components such as air-handling unit components

Ductwork sealing

J6D7 specifies the sealing of ductwork for large air-conditioning systems (capacity of 3000 L/S or greater). It specifies ductwork that is not located within the only or last room served by the system must be sealed from loss in accordance with AS 4254.1 and AS4254.2.

Pump systems

J6D8 set outs the minimum requirements for pumps which form part of an air-conditioning system. Table 4.16 summarises the key requirements of J6D8.

Table 4.16 Summary of key requirements for pumps

J6D8 reference	Key requirements
(1) Application	<ul style="list-style-type: none"> • Pumps and pipework which form part of an air-conditioning system must: <ul style="list-style-type: none"> – separately comply with J6D8 (2) to (4) – achieve a pump motor power per unit of flow rate lower than the pump motor power per unit of flowrate achieved when applying the provisions of J6D8.



J6D8 reference	Key requirements
(2) Circulator pumps	<ul style="list-style-type: none"> Glandless impeller pump with a rated output of less than 2.5 kW and used in closed loop systems Energy efficiency index (EEI) less than 0.27 EEI must be calculated in accordance with European Union Commission Regulation No. 622/2012.
(3) Other pumps	<ul style="list-style-type: none"> Other pumps must be in accordance with European Union Commission No. 547/2012 articles No. 1 and 2. EEI of at least 0.4. EEI must be calculated in accordance with European Union Commission Regulation No. 622/2012
(4) Pipework	<ul style="list-style-type: none"> Applies to straight sections of pipework along the index run that form part of the air-conditioning system. For pipework systems that do not have any branches and have the same flow rate through the entire network, an average pressure drop less than the value specified in Table J8D8a or J8D8b. For any other pipework system, an average pressure drop less than the value specified in Table J8D8c or J8D8d.
(5) Exemptions	<ul style="list-style-type: none"> (4) does not apply to: <ul style="list-style-type: none"> valves and fittings pipework, where the smallest pipe size compliant with (4) results in a velocity of less than 0.7 m/s design flow.

Pipework insulation

J6D9 specifies the DTS requirements for pipework insulation for piping, vessels and tanks which contain heating or cooling fluids. Table 4.17 provides a summary of the key requirements for J6D9.

Table 4.17 Summary of requirements for pipework insulation

J6D9	Key requirements
(1) Application	<ul style="list-style-type: none"> Requires insulation for piping, vessels, heat exchangers and tanks containing heating and cooling fluid held at a heated or cooled temperature. Insulation must:



	<ul style="list-style-type: none">– comply with AS4859.1– for piping used heating and cooling, have an R-Value in accordance with Table J6D9a– for vessels, heat exchangers or tanks, have insulation in accordance with Table J6D9b– for refill or pressure relief piping, have insulation with an R-Value equal to the required insulation value of the connected pipe, vessel or tank within 500 mm of the connection.
(2) Insulation installation	<ul style="list-style-type: none">• Insulation must be:<ul style="list-style-type: none">– protected against the effects of weather and sunlight– able to withstand the temperatures within the piping, vessel, heat exchanger or tank.
(3) Vapour barrier protection	<ul style="list-style-type: none">• Vapour barriers are required to be installed on the outside of insulation provided for piping, vessels, heat exchangers or tanks
(4) Exemptions	<ul style="list-style-type: none">• The requirements of (1) and (2) do not apply to piping, vessels or heat exchangers:<ul style="list-style-type: none">– located in the only or last room served by the system and downstream of the control device for the regulation of heating or cooling service to that room– encased within concrete slab or panel which is part of a heating or cooling system– supplied as an integral part of a chiller, boiler or unitary air-conditioner complying with the requirements of J6D 10 to J6D12– inside an air-handling unit, fan-coil unit or similar.
(5) Definitions	<ul style="list-style-type: none">• For the purposes of (1) to (4):<ul style="list-style-type: none">– heating fluids include refrigerant, heated water, steam and condensate– cooling fluids include refrigerant, chilled water, brines and glycol mixtures but do not include condenser cooling water.

**Alert**

AS 4859.1 specifies requirements and methods of testing of materials that are used in opaque envelopes of buildings and building services to provide thermal insulation. This includes ductwork and pipework. DTS Provisions are based on AS 4859.1 calculation methods.

Space heating

The minimum requirements for space heating can be found in J6D10. Table 4.18 summarises the key requirements for J6D10.

Table 4.18 Summary of requirements for space heating

J6D10 reference	Key requirements
(1) Heaters	<ul style="list-style-type: none"> • Specifies that heaters used for air-conditioning must be one of the following: <ul style="list-style-type: none"> – a solar heater – a gas heater – a heat pump heater – a heater which reclaims heat from another process – an electric heater – any combination of the above. • An electric heater must have the following properties: <ul style="list-style-type: none"> – a heating capacity of 10 W/m² for climate zone 1 – a heating capacity of 10 W/m² for climate zone 2 – a heating capacity as specified in Table J6D10 where reticulated gas is not available to the allotment boundary – an annual energy consumption of 15 kWh/m² or less for climate zones 1 to 5 – an in-duct heater must comply with J6D3(1)(b)(iii).
(2) Bathroom heating	<ul style="list-style-type: none"> • Bathrooms in an apartment building can be heated with an electric heater with a capacity of 1.2 kW or less
(3) Outdoor spaces	<ul style="list-style-type: none"> • Where a fixed heating or cooling appliance moderates the temperature of an outdoor space, it must be able to automatically shutdown when: <ul style="list-style-type: none"> – there are no occupants



	<ul style="list-style-type: none"> – it has been running for an hour – the space has reached the designed temperature.
(4) Gas water heater	<ul style="list-style-type: none"> • Where a gas water heater is used as part of an air-conditioning system it must: <ul style="list-style-type: none"> – achieve a minimum gross thermal efficiency of 86%, if rated to consume 500 MJ/hour of gas or less – achieve a minimum gross thermal efficiency of 90% if rated to consume more than 500 MJ/hour of gas.

Unitary air-conditioning equipment

J6D12 specifies the minimum requirements for unitary air-conditioning equipment. Table 4.19 provides a summary of the key requirements of J6D12.

Table 4.19 Summary of unitary air-conditioning equipment

J6D12(1) reference	Key requirement
(a) Cooled water	<ul style="list-style-type: none"> • Air-conditioning equipment must have a minimum energy efficiency ratio of $4.0 W_r/W_{inputpower}$ for cooling in accordance with AS/NZS 3823.1.2³⁷, at test condition T1.
(b) Cooled air	<ul style="list-style-type: none"> • Air-conditioning equipment must have a minimum energy efficiency of $2.9 W_r/W_{inputpower}$ cooling in accordance with AS/NZS 3823.1.2 at test condition T1

4.1.2.5 Artificial lighting and power

Part J7 aims to limit unreasonable energy use from artificial lighting and power.

Apart from clause numbering, the DTS Provisions for artificial lighting and power are unchanged for NCC 2022 when compared to NCC 2019.

A summary of the relevant clauses on artificial lighting and power that apply to the common areas of an apartment building is outlined in Table 4.20.

³⁷ AS/NZS 3823.1.2 Performance of electrical appliances – Air conditioners and heat pumps – Ducted air conditioners and air-to-air heat pumps – Testing and rating for performance.



Table 4.20 Artificial lighting and power clauses

Artificial lighting and power	Clause reference
Application	J7D2
Artificial lighting	J7D3
Interior artificial lighting and power control	J7D4
Interior decorative and display lighting	J7D5
Exterior artificial lighting	J7D6
Boiling water and chilled water storage units	J7D7
Lifts	J7D8
Escalators and moving walkways	J7D9

To assist in determining compliance, a Lighting Calculator is available from the Resource Library on the [ABCBC website](#).

Application

Part J7 sets out the requirements for artificial lighting and power. It applies to several building classifications, including the common areas of an apartment building. It defines the requirements for power usage for artificial lighting systems within buildings, as well as power requirements for boiling and chilled water units, lifts, escalators, and moving walkways.

Artificial lighting

J7D3 contains the requirements for artificial lighting. A summary of the key artificial lighting requirements for an apartment building is provided in Table 4.21.

Table 4.21 Key requirements for artificial lighting in an SOU

J7D3 subclause reference	Key requirements
(2) Lighting in common areas of Class 2 buildings	<ul style="list-style-type: none"> The maximum illumination power density allowances are specified in Table J7D3a for various types of spaces and building class. For common rooms, spaces and corridors of an apartment building the allowance is 4.5W/m². The aggregate design illumination power load must be less than or equal to the maximum illumination power density allowance.



J7D3 subclause reference	Key requirements
	<ul style="list-style-type: none"> The aggregate design illumination power load is the sum of the design illumination power load in each of the spaces served.
(3) Exemptions	<ul style="list-style-type: none"> The requirements of (1) and (2) do not apply to the following: <ul style="list-style-type: none"> Emergency lighting provided in accordance with Part E4 Signage, display lighting within cabinets and display cases that are fixed in place A heater where the heater also emits light, such as in bathrooms Lighting installed solely to provide photosynthetically active radiation for indoor plant growth on green walls and the like.
(4) Additional requirements	<ul style="list-style-type: none"> Table J7D3b, the following control devices must comply with Specification 40: <ul style="list-style-type: none"> Lighting timers Motion detectors Daylight sensors and dynamic lighting control devices.

A summary of the applicable clauses from J7D4 and J7D5 is in Table 4.22.

Table 4.22 Summary of key requirements from J7D4 and J7D5

Clause reference	Key requirement
J7D4(1)	<ul style="list-style-type: none"> Specifies that artificial lighting in a room or space must be individually controlled by a switch, other control device or combination of these two
J7D4(3)(a)	<ul style="list-style-type: none"> Requires that artificial lighting switches must be located in visible and easily accessed locations Be located in the room or space being switched or in an adjacent room or space, where 90% of the lighting being controlled is visible
J7D4(7)	<ul style="list-style-type: none"> Artificial lighting in foyers corridors and other circulation spaces must be controlled by devices in accordance with Specification 40, if they are 250 W or more within a single zone and adjacent to windows
J7D5(1)	<ul style="list-style-type: none"> Specifies interior decorative lighting, like foyer mural or art displays must be controlled



- Separately from other artificial lighting, by a manual switch and by a time switch, in accordance with Specification 40, if the display lighting exceeds 1kW

Exterior artificial lighting

Clause J7D6 requirements cover external lighting attached to or directed at the façade of a building. External lighting such as garden lighting, pathway lighting and the like are exempt from the NCC. A summary of the clauses in J7D6 is in Table 4.23.

Table 4.23 Summary of requirements for exterior artificial lighting

J7D6 reference	Key requirement
(1) Exterior lighting	<ul style="list-style-type: none"> • Provides controls for exterior lighting directed or attached the façade of the buildings • Must be controlled by day light sensors or time switches • Options for when total lighting load exceeds 100 W: <ul style="list-style-type: none"> – Option 1 - Use LED luminaires for 90% of the total lighting load – Use motion detectors in accordance with Specification 40 – Have a separate time switch in accordance with Specification 40 when used for decorative purposes. • Window display lighting must be controlled separately from other display lighting
(2) Exemption	<ul style="list-style-type: none"> • (1)(b) does not apply to emergency lighting in accordance with Part E4

Boiling water and chilled water storage units

J7D7 provides the minimum power requirements for boiling water and chilled water storage units. It specifies that the power supply for boiling or chilled water systems must be fitted with a time switch. The time switch must be in accordance with Specification 40.

Lifts

The minimum power requirements for lifts are in J7D8. A summary of the key requirements in J7D8 is in Table 4.24.



Table 4.24 Summary of power requirements for lifts

J7D8 reference	Key requirement
(a) Artificial lighting and ventilation	Artificial lighting and ventilation in a lift car must turn off when unused for 15 minutes
(b) Energy performance	Lifts must achieve the idle and standby energy performance levels in Table J7D8a
(c) Energy efficiency	Lifts must achieve the relevant energy efficiency class in Table J7D8b A dedicated goods lift must achieve energy efficiency class D in accordance with ISO 25745-2 Energy performance of lifts, escalators and moving walks – Part 2: Energy calculation and classification for lifts (elevators)

Escalators and moving walkways

J7D9 specifies the minimum power requirements for escalators and moving walkways. It requires escalators and moving walkways to be capable of slowing down to between 0.2m/s and 0.05 m/s if unused for 15 minutes.

4.1.2.6 Heated water supply, swimming pool and spa pool plant

Part J8 Heated water supply and swimming pool and spa pool plant contains requirements for ensuring water heaters, swimming pool and spa heaters and pump systems use energy efficiently. There are 3 relevant clauses in Part J8. These are listed in Table 4.25.

Table 4.25 Heated water supply, swimming pool and spa pool plant clauses

Heated water supply and swimming pool and spa pool plant	Clause reference
Heated water supply	J8D2
Swimming pool heating and pumping	J8D3
Spa pool heating and pumping	J8D4

Heated water supply

J8D2 states that heated water supply systems for food preparation and sanitary purposes must be designed and installed in accordance with Part B2 of NCC Volume Three - the Plumbing Code of Australia (PCA).

**Alert**

State and territory plumbing legislation may already require compliance with certain plumbing and drainage standards irrespective of the NCC requirements.

Swimming pool heating and pumping

J8D3 outlines the minimum requirements for swimming pool pumps and associated heating. Table 4.26 provides a summary of the requirements of J8D3.

Table 4.26 Key requirements for swimming pool heating and pumping

J8D3 reference	Key requirement
(1) Swimming pool heaters	<ul style="list-style-type: none"> • Requires that heating for swimming pools must come from: <ul style="list-style-type: none"> – a solar heater – a heater using reclaimed heat – geothermal heater – a gas heater – a heat pump – a combination of the above. • The following applies to a gas heater: <ul style="list-style-type: none"> – achieve a minimum gross thermal efficiency of 86%, if rated to consume 500MJ/hour of gas or less – achieve a minimum gross thermal efficiency of 90% if rated to consume more than 500MJ/hour of gas.
(2) Swimming pool gas heaters or heat pumps	<ul style="list-style-type: none"> • Applies to a gas heater or heat pump heater in (1) • A cover with a minimum R-Value of R0.05 is required • A time switch to control the operation of the heater is required
(3) and (4) Time switches	<ul style="list-style-type: none"> • Circulation pumps for swimming pools must be provided with a time switch to control its operation • When a required time switch is installed, it must be able to switch on and off electric power at variable pre-programmed times and days
(5) Pipework insulation	<ul style="list-style-type: none"> • Insulation, in accordance with J6D9, must be provided to pipework carrying heated or chilled water for a swimming pool



(6) Exemption	<ul style="list-style-type: none"> • A spa pool is not considered a swimming pool for the purposes of J8D3
---------------	---

Spa pool heating and pumping

J8D4 provides the DTS requirements for spa pool heating and pumping. The key requirements of J8D4 are summarised in Table 4.27.

Table 4.27 Summary of key requirements for spa pool and pumping

J8D4 reference	Key requirements
(1) Spa pool heaters	<ul style="list-style-type: none"> • Requires that heating for swimming pools must come from: <ul style="list-style-type: none"> – a solar heater – a heater using reclaimed heat – a geothermal heater – a gas heaters – a heat pump – a combination of the above
(2) Spa pool gas heaters or heat pumps	<ul style="list-style-type: none"> • If a spa pool is heated by a gas heater or heat pump, it is required to have a cover with a minimum R-Value of R0.05 and a time switch to control the operation of the heater
(3) Time switches	<ul style="list-style-type: none"> • Circulation pumps for spa pools, when they have a capacity greater than 680L, must be provided with a time switch for control
(4) Time switches	<ul style="list-style-type: none"> • When a required time switch is installed, it must be able to switch on and off electric power at variable pre-programmed times and days
(5) Pipework insulation	<ul style="list-style-type: none"> • Insulation, in accordance with J6D9, must be provided to pipework carrying heated or chilled water for a swimming pool

Table 4.28 Key requirements for spa pool heating and pumping

J8D3 reference	Key requirement
(1) Spa pool heaters	<ul style="list-style-type: none"> • Requires that heating for swimming pools must come from: <ul style="list-style-type: none"> – a solar heater – a heater using reclaimed heat – a geothermal heater – a gas heater



	<ul style="list-style-type: none"> – a heat pump – a combination of the above. • The following applies to a gas heater: <ul style="list-style-type: none"> – achieve a minimum gross thermal efficiency of 86%, if rated to consume 500MJ/hour of gas or less – achieve a minimum gross thermal efficiency of 90% if rated to consume more than 500MJ/hour of gas.
(2) Spa pool gas heater or heat pump	<ul style="list-style-type: none"> • Applies to a gas heater or heat pump heater in (1) • A cover with a minimum R-Value of R0.05 is required • A time switch to control the operation of the heater is required
(3) and (4) Time switches	<ul style="list-style-type: none"> • Applies to a spa pool with a capacity of 680 L or more • A circulation pump for a spa pool must be provided with a time switch to control its operation • When a required time switch is installed, it must be able to switch on and off electric power at variable pre-programmed times and days
(5) Pipework insulation	<ul style="list-style-type: none"> • Insulation, in accordance with J6D9, must be provided to pipework carrying heated or chilled water for a spa pool

4.1.2.7 Energy monitoring and on-site distributed energy resources

Part J9 contains requirements that enable the monitoring of energy use (other than for billing purposes) and facilitate easy retrofit of renewable energy and EV charging equipment.

Part J9 has 4 main subclauses which are listed in Table 4.29.

Table 4.29 Energy monitoring and on-site distributed energy resources

Energy monitoring and on-site distributed energy resources	Clause reference
Application of Part	J9D2
Facilities for energy monitoring	J9D3
Facilities for electric vehicle charging equipment	J9D4
Facilities for solar photovoltaic and battery systems	J9D5

J9D4 and J9D5 are new for NCC 2022. These DTS Provisions were introduced as a deemed-to-comply option to comply with new Performance Requirement J1P4 Renewable energy and electric vehicle charging.



Application

J9D2 specifies that the provisions in Part J9 do not apply within an SOU in an apartment building.

Facilities for monitoring energy

J9D3 outlines the DTS requirements for the monitoring of energy usage in buildings. Table 4.30 provides a summary of the J9D3.

Table 4.30 summary of facilities for energy monitoring

J9D3 reference	Key requirement
(1) Energy metering (above 500 m ²)	<ul style="list-style-type: none"> • Applies to a building or an SOU that has a floor area greater than 500m² • Energy meters which are configured to record the time of use consumption of gas and electricity must be provided
(2) Energy metering (above 2500 m ²)	<ul style="list-style-type: none"> • Applies to a building or an SOU that has a floor area greater than 2500m² • Energy meters must be provided which record individual time-of use energy data for the following: <ul style="list-style-type: none"> – air-conditioning plant – artificial lighting – appliance power – central hot water – internal transport devices, such as lifts – on-site renewable energy equipment – on-site electric vehicle charging equipment – on-site battery systems – other plant.
(3) Energy meters	<ul style="list-style-type: none"> • Where a meter is required by (2), it must be interlinked with a communication system that collates all time-of-use data for analysis and review
(4) exemptions	<ul style="list-style-type: none"> • Energy meters in accordance with (2) are not required for: <ul style="list-style-type: none"> – an apartment building with common areas less than 500 m² – an SOU with a floor area less than 2500 m²



Facilities for electric vehicle (EV) charging equipment

J9D4 contains the requirements to assist the future installation of EV charging equipment in the car parks of buildings. It does not require the installation of actual charging equipment in buildings.

Table 4.31 provides a summary of the key requirements for J9D4 for apartment buildings.

Table 4.31 Key requirements for facilities for EV charging equipment

J9D4 reference	Key requirements
(1) Electrical distribution boards	<ul style="list-style-type: none"> • Applies to a carpark associated with an apartment building • Requires electric distribution boards dedicated to EVs to be installed • The number of electrical distribution boards required for EV charging is per storey and in accordance with Table J9D4 • Electrical distribution boards must be labelled to indicate use for future EV charging equipment
(2) Electrical distribution boards	<ul style="list-style-type: none"> • Applies to electrical distribution boards required by (1) • Fitted with a charging control system with the ability to manage and schedule charging of EVs in response to total building demand • Have the capacity for each circuit to support an EV charger able to deliver a minimum of 12 kWh from 11:00 am to 7:00 am daily • Be sized to support the future installation of a 7 kW(32A) type 2 EV charger in 100% of the car parking spaces • Contain space of at least 36 mm width of DIN³⁸ rail per outgoing circuit for individual sub-circuit electricity metering to record electricity use of EV charging equipment • Be labelled to indicate the use of space required for the future installation of metering equipment

³⁸ Deutsches Institut für Normung (German Institute for Standardization)

**Alert**

J9D4 applies only to carparks associated with an apartment buildings. The provisions of this Part do not apply within an SOU of a Class 2 building.

Facilities for solar photovoltaic and battery systems

J9D5 contains requirements to assist the future installation of PV and battery systems in buildings. It does not require the installation of this equipment.

A summary of the key requirements for J9D5 can be found in Table 4.32.

Table 4.32 Summary of the key requirements for J9D5

J9D5 reference	Key requirements
(1) Main electrical switch board	<ul style="list-style-type: none"> • Applies to the main electrical switch board • The following is required: <ul style="list-style-type: none"> – a minimum of 2 empty 3-phase circuit breaker slots – a minimum of 4 DIN rail spaces that are labelled to indicate the use of each space for a solar PV system and a battery system – sized to accommodate the installation of solar PVs producing their maximum electrical output on at least 20% of the building roof area.
(2) Roof area	<ul style="list-style-type: none"> • At least 20% of the roof area of a building must be left clear for installation of solar PVs. • This requirement does not apply to the following: <ul style="list-style-type: none"> – when solar PVs are installed on at least 20% of the area or an equivalent generation capacity elsewhere on-site – when 100% of the roof area is shaded for 70% of daylight hours – a roof area of 55 m² or less – when more than 50% of the roof area is used as a terrace, carpark, roof garden, roof light or similar.
Limitations	<ul style="list-style-type: none"> • (1)(a)(i) and (1)(b) do not apply to a building with solar PV panels installed on at least 20% of the roof • (1)(a)(ii) and (1)(b) do not apply to a building with a battery system installed



4.1.3 Useful tips

4.1.3.1 Building fabric

Building fabric thermal insulation

- Guidance on installing bulk insulation is in AS/NZS 4859.1 - Materials for the thermal insulation of buildings: General criteria and technical provisions. This Standard specifies the testing criteria for insulation, including both reflective and bulk insulation.
- In addition to meeting the DTS Provisions for energy efficiency, the selection and installation of reflective and bulk insulation must meet other NCC requirements for example, Part F8 of Volume One.

Roofs and ceilings

- J4D4(1) details the insulation properties and minimum Total R-Value required of a roof or ceiling. The Total R-Value may be provided by the roof construction itself and include any insulating properties of the roof and airspaces. If the Total R-Value provided by the roof is significant, the amount of insulation needed is reduced.
- The direction of heat flow refers to either heat flow into the building or heat loss out of the building and is based on conditions in each climate zone. Where “downwards” is specified, this indicates that summer heat (a downwards heat flow into the building) is the major concern. An “upwards” flow indicates that heat loss from the building during winter is the major concern.
- Typical solar absorptance ranges from around 0.30 for light cream, to 0.90 for a dark grey slate. Galvanised steel for example has a typical solar absorptance of around 0.55.

Thermal bridging

- The effect of thermal bridging must be considered by using the calculation method specified in AS/ NZ 4859.2 (2018) when determining if the minimum R-Value of a roof has been achieved. In some cases, thermal breaks will be necessary to achieve compliance.
- A thermal break may be provided by materials such as timber or expanded polystyrene strips, plywood or bulk insulation. Reflective insulation alone is not suitable for use as a thermal break because it requires an adjoining airspace to achieve the specified R-Value.
- Some products or construction systems can meet the thermal bridging and thermal break requirements simultaneously. For example, if a designer specifies continuous insulation between the lining and the frame, the lining is no longer fixed directly to the frame, so there is no need for an additional thermal break.
- If thermal bridging is instead addressed with extra insulation in the frames, a thermal break is still needed as the extra insulation does not prevent local cold/hot patches.



4.1.3.2 External glazing

- Solar absorptance of window frames: Darker frames conduct more heat from solar radiation and effectively increase the impact of solar gains through glazing. Darker frames improve performance in winter and decrease it in summer.
- Window products and their thermal performance (Total System U-Value and Total System SHGC) are available from the Window Energy Rating Scheme (WERS)

4.1.3.3 Building sealing

- Air leakage most commonly occurs at the:
 - roof/ceiling to wall junction
 - floor to wall junction
 - wall to door frame junction
 - wall to window frame junction
 - all services penetrations.
- In addition to the sealing requirements for chimneys and flues, Part G2 of NCC Volume One contains requirements that also need to be met.
- For exhaust fans, a simple flap damper system can fulfil the minimum requirements. These are readily available for most fan types. Alternatively, a mesh filter system, like those used in kitchen range hoods, is acceptable. This is because these systems significantly restrict the flow of air when the fan is not operating.
- In J4D7(2) that covers the construction of ceilings, walls and floors, the term 'close-fitting' is used, but what does this term mean? Since doors and windows require a compressible seal, it would not be acceptable to have visible gaps surrounding the window or door unit. Therefore, a reasonable interpretation of 'close fitting' could be a gap less than that between the compressible seal of a closed window or door and the associated frame.

4.1.3.4 Air-conditioning and ventilation

- Ductwork insulation needs to be protected from the effects of weather as required by clause J6D6. In the case of using a membrane for vapour barrier for conveying cool air, the adjoining sheets need to have a minimum overlap 50 mm and bond or tapped together.
- See NCC Volume Three for more information on the requirements for water heaters in a heated water supply system.

4.1.3.5 Artificial lighting and power

- The ABCB provides a Lighting Calculator for Volume One (see the [ABCB website](#)), which can be used to assist in reviewing lighting power usage for apartment building common



areas and individual SOUs. This tool can be used to quickly check the effects of changes to a lighting to system when updating, amending or optimising.

4.1.3.6 Energy monitoring and on-site distributed energy

Energy monitoring

- All buildings with a floor area greater than 500 m² must have a means of recording the consumption of gas and electricity.
- For buildings with a floor area no larger than 2,500 m², this need only be whole-of-building metering such as an electricity supply meter and/or a gas supply meter (whichever service is provided).
- Buildings with a floor area greater than 2,500 m² must also have the means to record individually the energy consumption of nominated main services as specified in clause J9D3(2)(a) to (i). However, the requirements are not applied to Class 2 buildings where the total floor area of the common areas is less than 500 m².

EV charging equipment

- For useful tips on EV charging equipment refer to the ABCB's Advisory notice on Electrical vehicles in buildings, which is available from the [ABCB website](#).

Solar PV and battery systems

- J9D4 doesn't require the installation of any solar PV or battery systems, just sufficient space on electrical switchboards and physical roof space dedicated to it. This is to make it easier for their installation in the future.

4.1.4 Demonstrating compliance

4.1.4.1 Assessment Methods for DTS Solutions

An overview of how to comply and demonstrate compliance with the NCC is in Appendix C of this document, with further guidance available from the ABCB website.

The DTS Provisions that form the Elemental compliance option are used to demonstrate NCC compliance using a DTS Solution.

A2G3(2) sets out the following Assessment Methods as being suitable for demonstrating compliance for DTS Solutions:

- Evidence of suitability (NCC clauses A2G2, A2G3, A5G1 to A5G4).
- Expert Judgement (NCC clauses A2G2 and A2G3 of the NCC).

The following provides further information on these Assessment Methods.



4.1.4.2 Evidence of suitability

Evidence of suitability, also known as 'documentary evidence', can generally be used to support that a material, product, form of construction or design satisfies a DTS Provision. Subject to certain NCC provisions, the form of evidence that may be used consists of one, or a combination, of the following:

- A report from an Accredited Testing Laboratory.
- A Certificate of Conformity or a Certificate of Accreditation.
- A certificate from a professional engineer or appropriately qualified person.
- A current certificate issued by a product certification body that has been accredited by JAS-ANZ.
- Any other form of documentary evidence that adequately demonstrates suitability such as a Product Technical Statement.

More information on this Assessment Method is available in the ABCB Evidence of Suitability Handbook (2021).

In relation to housing energy efficiency, individual jurisdictions may have issued directions or notices specifying what documentary evidence is considered acceptable to demonstrate compliance.

4.1.4.3 Expert Judgement

Where physical criteria is unable to be tested, or modelled by calculation, the opinion of an expert may be accepted. Expert Judgment is the judgement of a person who has the qualifications and experience necessary to determine whether a Performance Solution or DTS Solution complies with the Performance Requirements.

It is the role of the appropriate authority to determine whether a person providing an Expert Judgement is considered an expert. More information on the use of Expert Judgement including guidance on who may be considered an expert is in the resource Understanding the NCC – Assessment Methods, which is available from the [ABC B website](#).

The energy efficiency of a proposed apartment building is readily determined by impartial methods such as evidenced-based calculations; therefore, Expert Judgement is inappropriate as a sole Assessment Method for assessing a DTS Solution for an apartment building.

4.2 Compliance Option 2: J1V1 NABERS Energy

4.2.1 Introduction

J1V1 NABERS Energy is a Verification Method that can be used as part of a Performance Solution to assess if a proposed solution complies with the Performance Requirement J1P1.



NABERS Energy is the National Australian Built Environment Rating System for energy efficiency.

J1V1 can be used for a Class 3, 5 and 6 building and the common areas of an apartment building. Prior to NCC 2022, this method was limited to Class 5 (office) buildings only.

4.2.2 Method

J1V1 allows the use of building commitment agreement modelling protocols and schedules from NABERS Energy to demonstrate compliance with J1P1 for the common areas of an apartment building.

A commitment agreement is obtained when the property owner/developer receives a counter signed commitment agreement from the NABERS National Administrator. Obtaining a commitment agreement helps ensure the necessary rating will be verified through the NABERS Energy process; and the design will be followed through to construction completion and into the building's operation. Current commitment agreements are listed on the [NABERS website](#).

J1V1(2) outlines the process for the common areas of apartment buildings. This is shown in Figure 4.3. A summary of the key requirements of J1V1(2) is in Table 4.33.

Figure 4.3 J1V1(2) for common areas of an apartment building

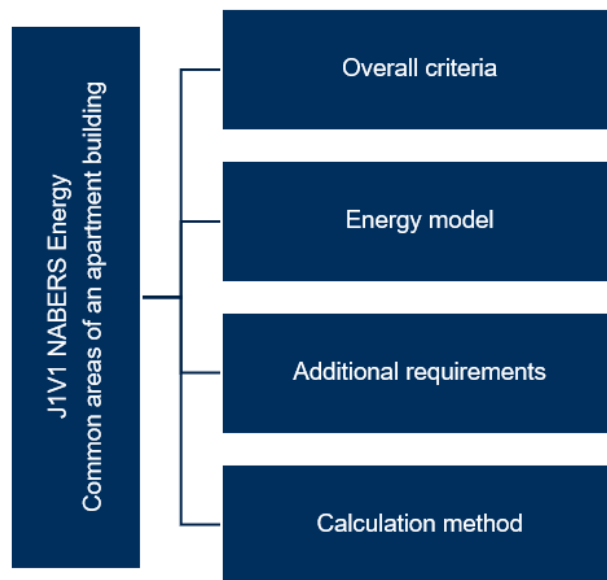



Table 4.33 Key requirements for J1V1 for common areas of apartment buildings

Clause J1V1(2) reference	Key requirements
(2)(a) and (2)(b) Overall criteria	<ul style="list-style-type: none">• A minimum 4-star NABERS Energy for Apartment Buildings Commitment Agreement is obtained• The minimum air-conditioning hours is 18 hours/day for all enclosed common lift lobbies and corridors
(2)(c) Energy model	<ul style="list-style-type: none">• The energy model required for (2)(a) must demonstrate the following:<ul style="list-style-type: none">– the greenhouse gas (GHG) emissions of the services are less than 90% of the 5-star level– a thermal comfort level of between a Predicted Mean Vote (PMV) of -1 to +1 across not less than 95% of the floor area of all occupied zones– the thermal comfort level must be demonstrated for not less than 98% of the annual hours of operation of the building– the space temperature in any indoor swimming pool chamber is maintained at 2°C above the pool temperature during occupied hours (not less than 12 hours per day).
(2)(d) Additional requirements	<ul style="list-style-type: none">• The building must comply with the additional requirements in Specification 33. Refer Table 4.34 below
(5) Calculation method	<ul style="list-style-type: none">• The calculation method must comply with ANSI/ASHRAE Standard 140

**Alert:**

ANSI/ASHRAE Standard 140 2007 is the Standard Method of test for the Evaluation of Building Energy Analysis Computer Programs. ANSI/ASHRAE Standard 140 specifies test procedures for evaluating the technical capabilities of software used to calculate the thermal performance of buildings and their HVAC systems.

Table 4.34 Additional requirements from Specification 33

S33C2 reference	NCC reference/requirement
(a) General thermal construction	<ul style="list-style-type: none"> • J4D3
(b) Floor edge insulation	<ul style="list-style-type: none"> • J4D7(2) and J4D7(3)
(c) Building sealing	<ul style="list-style-type: none"> • J1V4 or Part J5
(d) Air-conditioning and mechanical ventilation systems	<ul style="list-style-type: none"> • Covers deactivation, control and insulation: <ul style="list-style-type: none"> – J6D3(1)(a), J6D3(1)(b)(i) – J6D3(1)(d), J6D3(1)(f) – J6D3(2) and (3) – J6D4(2) and (4) – J6D5, J6D6 and J6D9
(e) Packaged air-conditioning equipment	<ul style="list-style-type: none"> • Applies to equipment not less than 65 kW_r • AS/NZS 3823.1.2 at test condition T1
(f) Refrigeration system	<ul style="list-style-type: none"> • Applies to testing a refrigeration chiller • AHRI 551/591
(g) Interior artificial lighting and power control	<ul style="list-style-type: none"> • J7D4
(h) Interior decorative and display lighting	<ul style="list-style-type: none"> • J7D5
(i) Artificial lighting around the exterior of a building	<ul style="list-style-type: none"> • J7D6
(j) Boiling water and chilled water storage units	<ul style="list-style-type: none"> • J7D7
(k) Deactivation of swimming pool heating and pumping	<ul style="list-style-type: none"> • J8D3(2)(b) and J8D3(3)



S33C2 reference	NCC reference/requirement
(l) Deactivation of spa pool heating and pumping	<ul style="list-style-type: none">J8D4(2)(b) and J8D4(3)
(m) Facilities for energy monitoring	<ul style="list-style-type: none">Part J9
(n) Deactivation of fixed outdoor space heating appliances	<ul style="list-style-type: none">J6D10(3)

4.2.3 Useful tips

- Verification Method J1V1 is limited to assessing compliance with Performance Requirement J1P1 only. Performance Requirement J1P4 needs to be satisfied through another compliance option.
- The intent of Verification Method J1V1 is to enable J1P1 to be met using NABERS Energy for the common areas of an apartment building without the need to separately show compliance using another NCC compliance option. This saves time and money.
- NABERS provides a rating from one to six stars for building efficiency across: energy, water, waste and indoor environment.
- More information on the 4-star NABERS Energy for Apartment Buildings Commitment Agreement, the predicted GHG emissions for the energy model and the 5-star level in J1V1(2)(c) is available in the Handbook for Estimating NABERS ratings available from the [NABERS website](#)
- An assessment of the PMV as part of J1V1 ensures that occupant comfort is not compromised in the pursuit of energy efficiency. The PMV index predicts the mean response of a large group of people on a 7-point thermal sensation scale, from +3 (hot) to -3 (cold) where 0 is neutral.
- A PMV of -1 to +1 means that 75% of people are satisfied and comfortable. Note, this is likely to be appropriate for buildings that meet the applicability criterion in Section 5.4.1 of ASHRAE 55-2013.
- NABERS ratings are valid for twelve months. This annual model helps ensure a rating represents a building or workplace's current operational performance.
- NABERS ratings should be performed by a NABERS Accredited Assessor and comply with the quality standard set in the principles and rules for gathering, interpreting and using data.



4.2.4 Demonstrating compliance

4.2.4.1 Background

A Performance Solution can be used in an individual situation where the desired solution meets the Performance Requirements of the NCC, but not the relevant DTS Provisions. These solutions are often flexible in achieving the outcomes required and encourage innovative design and technology use.

An overview of how to demonstrate compliance with the NCC is in Appendix C of this document, with further guidance available from the [ABCBC website](#).

J1V1 NABERS Energy is a Verification Method; therefore, where a Performance Solution utilises J1V1, Verification Method is the relevant Assessment Method. More information on Assessment Methods is in the resource Understanding the NCC – Assessment Methods, which is available from the [ABCBC website](#).

Reminder

‘Verification Method’ is an NCC defined term and means a test, inspection, calculation or other method that determines whether a Performance Solution complies with the relevant Performance Requirements.

4.2.4.2 Performance Solution process

To help ensure a Performance Solution provides the level of intended performance, clause A2G2(4) of the NCC mandates a process for developing Performance Solutions. This process must be followed regardless of whether the Performance Solution is simple or complex in nature.

In simple terms, the 4 steps of the Performance Solution process are:

- (1) prepare a brief
- (2) carry out analysis
- (3) evaluate results
- (4) prepare a final report.

More information on this process is in the Performance Solution Process Guidance Document and the ABCBC Performance Solution Process Handbook, which are available from the [ABCBC website](#).



4.2.4.3 Professional practice and ethics

Some state and territory legislation empowers certain practitioners to develop and/or approve Performance Solutions. Irrespective of controls about who can undertake this work, the practitioners involved have a professional responsibility for ensuring that appropriately skilled and experienced persons are engaged to develop and approve Performance Solutions.

When preparing a Performance Solution, practitioners should exercise their duties in an appropriate manner. Key principles include:

- **Acting in the public interest:** In undertaking their duties, a practitioner should exercise their discretionary powers in ways that safeguard the public interest. A practitioner's consideration of the interests of their clients and employers must not be contrary to the public interest.
- **Independence:** In performing their professional duties, a building surveyor/certifier should be objective, impartial and conduct themselves in accordance with the relevant requirements of state and territory legislation. Other practitioners should ensure any conflicts of interest are disclosed to all relevant parties.
- **Competence:** A practitioner should not undertake professional work that they are not competent to perform.



4.3 Compliance Option 3: J1V2 Green Star

4.3.1 Introduction

J1V2 Green Star is a Verification Method that can be used as part of a Performance Solution to assess if a proposed solution complies with the Performance Requirement J1P1.

Green Star – Design & As-Built rates buildings across a range of sustainability categories, including energy efficiency, and uses a similar methodology to the DTS Provisions.

J1V2 can be used for the common areas of a Class 2 apartment building.

4.3.2 Method

J1V2 allows the use of the Green Star - Design & As-Built rating tool to demonstrate compliance with J1P1 for the common areas of an apartment building.

Green Star – Design & As-Built and the DTS Provisions differ in scope slightly, however both Green Star and NCC Volume One Section J have the same objective of energy efficiency and reduced GHG consumption.

In simple terms, the method requires the annual GHG emissions of the proposed building to be less than 90% of the annual GHG emissions of a reference building. This is detailed in Figure 4.4.

The project is required to be registered for a Green Star - Design & As-Built rating to confirm its compliance with the Green Star – Design & As-Built modelling requirements. Registering the project ensures that the most recent Green Star – Design & As-Built rating tool is being used, reinforces the commitment to following through with the energy requirements, and adds a layer of oversight from the GBCA.

Figure 4. outlines the process for the common areas of apartment buildings.

A summary of the key requirements of J1V2 is in Table 4.35.



Figure 4.4 J1V2 – Comparison of GHG emissions

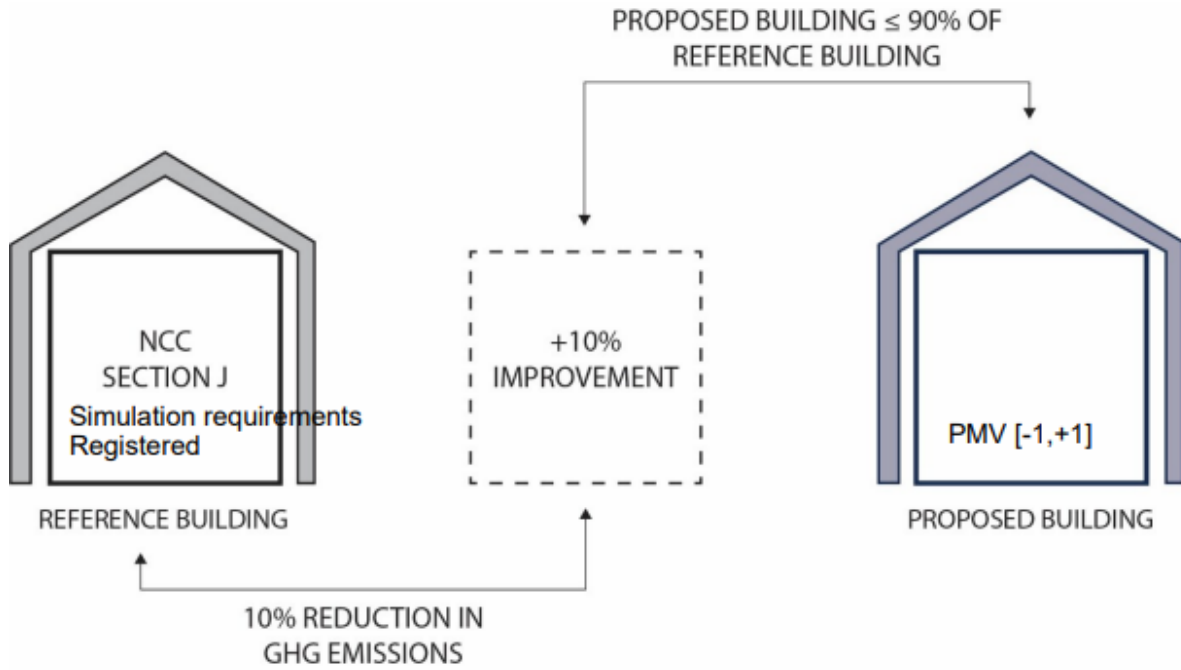

Figure 4.5 J1V2 for common areas of an apartment building

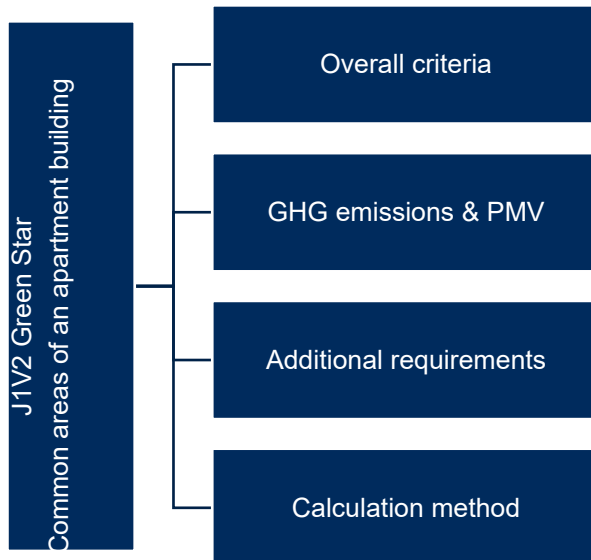



Table 4.35 Key requirements for J1V2 for common areas of apartment buildings

Clause J1V2 reference	Key requirements
(1)(a) Overall criteria	<ul style="list-style-type: none"> Registration and compliance with one of the following: <ul style="list-style-type: none"> Green Star – Design & As-Built Green Star Buildings Rating.
(1)(b) and (c) GHG emissions and PMV	<ul style="list-style-type: none"> The annual GHG emissions of the common areas of a proposed apartment building must be less than 90% of the annual GHG emissions of a reference building The common areas of a proposed apartment building must provide a thermal comfort level of between a PMV of -1 to +1 across not less than 95% of the floor area of all occupied zones The thermal comfort level must be demonstrated for not less than 98% of the annual hours of operation of the building
(1)(d) Additional requirements	<ul style="list-style-type: none"> The building must comply with the additional requirements in Specification 33 (refer Table 4.36 below)
(2) Calculation method	<ul style="list-style-type: none"> The calculation method must comply with ANSI/ASHRAE Standard 140

Alert:

ANSI/ASHRAE Standard 140 2007 is the Standard Method of test for the Evaluation of Building Energy Analysis Computer Programs. ANSI/ASHRAE Standard 140 specifies test procedures for evaluating the technical capabilities of software used to calculate the thermal performance of buildings and their HVAC systems.

Table 4.36 Additional requirements from Specification 33

S33C2 reference	NCC reference/requirement
(a) General thermal construction	<ul style="list-style-type: none"> J4D3
(b) Floor edge insulation	<ul style="list-style-type: none"> J4D7(2) and J4D7(3)
(c) Building sealing	<ul style="list-style-type: none"> J1V4 or Part J5
(d) Air-conditioning and mechanical ventilation systems	<ul style="list-style-type: none"> Covers deactivation, control and insulation:



S33C2 reference	NCC reference/requirement
	<ul style="list-style-type: none">– J6D3(1)(a), J6D3(1)(b)(i)– J6D3(1)(d), J6D3(1)(f)– J6D3(2) and (3)– J6D4(2) and (4)– J6D5, J6D6 and J6D9
(e) Packaged air-conditioning equipment	<ul style="list-style-type: none">• Applies to equipment not less than 65 kW_r• AS/NZS 3823.1.2 at test condition T1
(f) Refrigeration system	<ul style="list-style-type: none">• Applies to testing a refrigeration chiller• AHRI 551/591
(g) Interior artificial lighting and power control	<ul style="list-style-type: none">• J7D4
(h) Interior decorative and display lighting	<ul style="list-style-type: none">• J7D5
(i) Artificial lighting around the exterior of a building	<ul style="list-style-type: none">• J7D6
(j) Boiling water and chilled water storage units	<ul style="list-style-type: none">• J7D7
(k) Deactivation of swimming pool heating and pumping	<ul style="list-style-type: none">• J8D3(2)(b) and J8D3(3)
(l) Deactivation of spa pool heating and pumping	<ul style="list-style-type: none">• J8D4(2)(b) and J8D4(3)
(m) Facilities for energy monitoring	<ul style="list-style-type: none">• Part J9
(n) Deactivation of fixed outdoor space heating appliances	<ul style="list-style-type: none">• J6D10(3)

In addition, in S33C3, where not included in the building energy simulation to satisfy J1V2(1), compliance must be achieved:

- for heating, cooling and ventilation equipment outside the scope of the Green Star model, Part J6
- for artificial lighting outside the scope of the Green Star model, Part J7.



Alert

The Green Building Council of Australia (GBCA) is responsible for maintaining and updating the Green Star rating system. Refer to the [Green Building Council of Australia website](#) for information relating to the use of Green Star as a compliance option for apartment buildings to meet the relevant energy efficiency Performance Requirement in NCC 2022.

4.3.3 Useful tips

- Projects using the Green Star Buildings rating tool must achieve an As Built Certification. This certifies completed buildings (up to 2 years after practical completion) and confirms that the finished product delivers sustainable outcomes, and that everything is in place to ensure the building can be operated as sustainably as possible.
- The Green Star Buildings tool has been simplified, which does not require a model consistent with both the J1V3 modelling parameters and the Green Star modelling parameters anymore.
- In fulfilling the conditional requirement of the Green Star – Design & As-Built credit for ‘Greenhouse Gas Emissions Reduction – Reference Building Pathway’, a building exceeds the energy efficiency requirements of J1P1 for the common areas in a Class 2 building. However, the intent of the Verification Method is to allow buildings designed to achieve a Green Star – Design & As-Built rating to meet compliance without the need of separately showing compliance using the Verification Method J1V3, saving both time and money.
- To follow the conditional requirement of Green Star - Design & As-Built’s Greenhouse Gas Emissions Reduction – Reference Building Pathway, project teams must demonstrate that the proposed building’s GHG emissions are less than those of the equivalent Benchmark Building. A comparison of GHG emissions reconciles the different emission intensities of gas and electricity and allows credit for on-site renewable energy.
- An assessment of the PMV is also a requirement of Verification Method J1V2. This ensures that occupant comfort is not compromised in the pursuit of energy efficiency. The PMV index predicts the mean response of a large group of people on a 7-point thermal sensation scale, from +3 (hot) to -3 (cold) where 0 is neutral.
- The PMV metric is designed for fully mechanically ventilated buildings. If a building is either mixed-mode or naturally ventilated, the Adaptive Thermal Comfort metric may be more appropriate. The Adaptive Thermal Comfort metric relates indoor design temperatures to outdoor temperatures (i.e. higher room temperatures during warmer weather) based on the understanding that occupants can adapt to, or even prefer a wider range of conditions. This can be used as a Performance Solution subject to the approval of the Appropriate Authority.



Adaptive Thermal Comfort can also be used in combination with PMV in buildings that have both fully mechanical and partially naturally ventilated spaces as a Performance Solution.

- The additional requirements in Specification 33 also need to be met for compliance with J1P1.

4.3.4 Demonstrating compliance

4.3.4.1 Background

A Performance Solution can be used in an individual situation where the desired solution meets the Performance Requirements of the NCC, but not the relevant DTS Provisions. These solutions are often flexible in achieving the outcomes required and encourage innovative design and technology use. An overview of how to demonstrate compliance with the NCC is in Appendix C of this document, with further guidance available from the [ABCB website](#).

J1V2 Green Star is a Verification Method; therefore, where a Performance Solution utilises J1V2, Verification Method is the relevant Assessment Method. More information on Assessment Methods is in the resource Understanding the NCC – Assessment Methods, which is available from the ABCB website.

Reminder

‘Verification Method’ is an NCC defined term and means a test, inspection, calculation or other method that determines whether a Performance Solution complies with the relevant Performance Requirements.

4.3.4.2 Performance Solutions process

To help ensure a Performance Solution provides the level of intended performance, clause A2G2(4) of the NCC mandates a process for developing Performance Solutions. This process must be followed regardless of whether the Performance Solution is simple or complex in nature.

In simple terms, the 4 steps of the Performance Solution process are:

- (1) prepare a brief
- (2) carry out analysis
- (3) collate and evaluate results
- (4) prepare a final report.

More information on this process is in the Performance Solution Process Guidance Document and the ABCB Performance Solution Process Handbook, which are available from the [ABCB website](#).



4.3.4.3 Professional practice and ethics

Some state and territory legislation empowers certain practitioners to develop and/or approve Performance Solutions. Irrespective of controls about who can undertake this work, the practitioners involved have a professional responsibility for ensuring that appropriately skilled and experienced persons are engaged to develop and approve Performance Solutions.

When preparing a Performance Solution, practitioners should exercise their duties in an appropriate manner. Key principles include:

- **Acting in the public interest:** In undertaking their duties, a practitioner should exercise their discretionary powers in ways that safeguard the public interest. A practitioner's consideration of the interests of their clients and employers must not be contrary to the public interest.
- **Independence:** In performing their professional duties, a building surveyor/certifier should be objective, impartial and conduct themselves in accordance with the relevant requirements of state and territory legislation. Other practitioners should ensure any conflicts of interest are disclosed to all relevant parties.
- **Competence:** A practitioner should not undertake professional work that they are not competent to perform.

4.4 Compliance Option 4: J1V3 Verification using a reference building

4.4.1 Introduction

J1V3 Verification using a reference building (VURB) is a Verification Method that can be used as part of a Performance Solution to demonstrate compliance with the Performance Requirement J1P1. It can be used instead of the DTS Provisions of Parts J1 to J8.

J1V3 VURB is applicable to the common areas of an apartment building (and other commercial building classes). It does not apply to an SOU of an apartment building.

Error! Reference source not found. summarises the relevant requirements that form J1V3. These requirements are discussed in further detail in this chapter.

Figure 4.6 J1V3 VURB

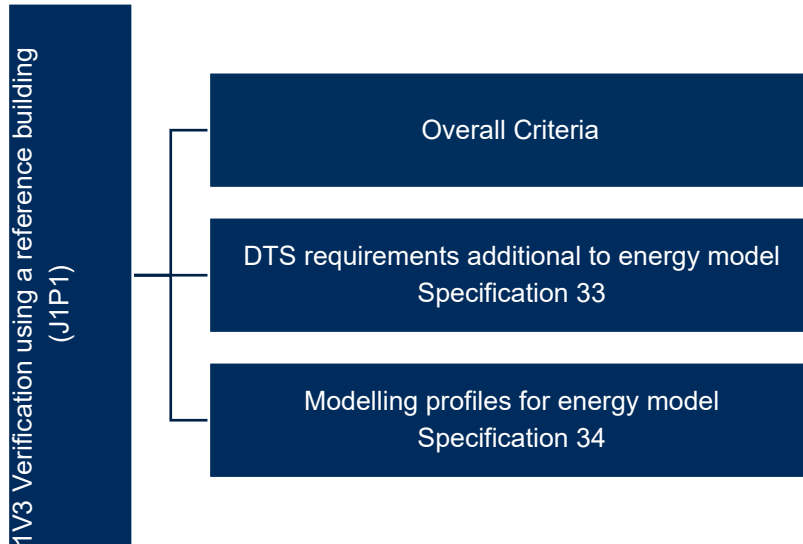
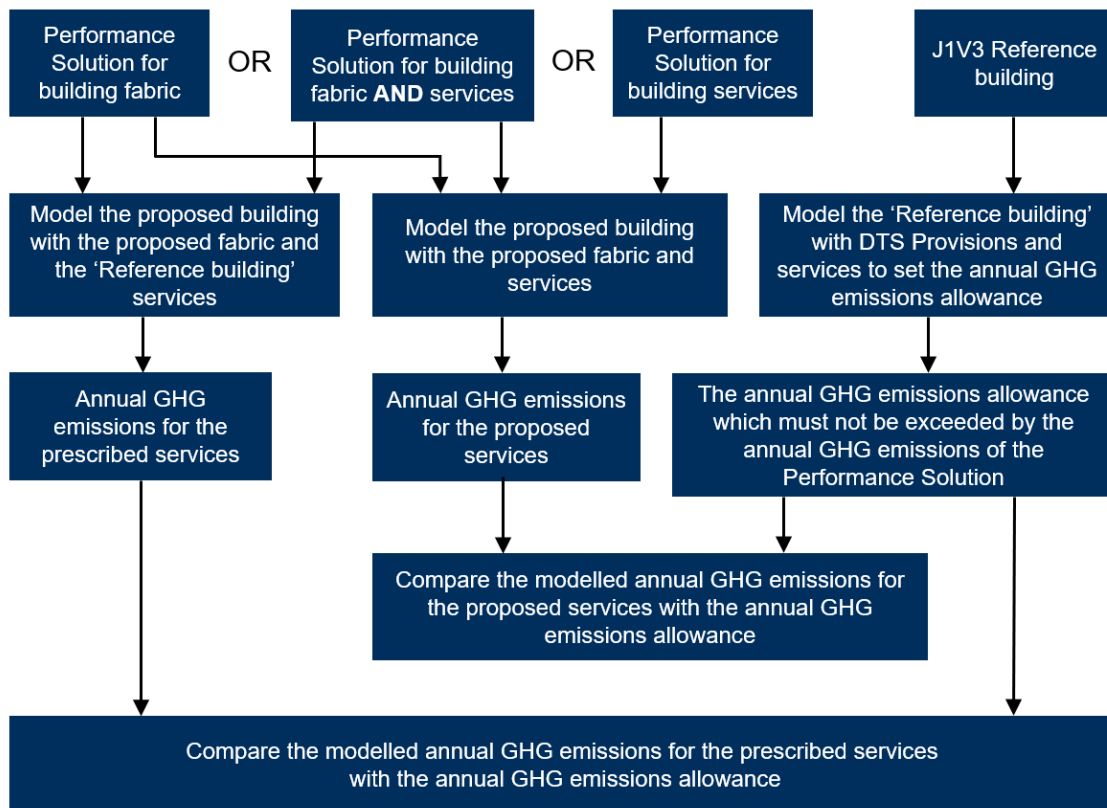

Figure 4. illustrates how J1V3 can be used as part of different Performance Solutions.

Figure 4.7 Using Verification Method J1V3





4.4.2 Method

This method is a comparative assessment. The basic approach is that the annual GHG emissions of the proposed building must not be more than the annual GHG emissions of a complying reference building which is based on the DTS Provisions.

In J1V3(a), the following two scenarios must be met:

- J1V3(1)(a)(i) with the proposed services in the proposed building and services complying with the DTS Provisions for the reference building; and
- J1V3(1)(a)(ii) with the same services in both cases that comply with the DTS Provisions.

These two theoretical scenarios are necessary because, if only subclause J1V3(1)(a)(i) was required, the thermal performance of the building’s envelope could be “traded-off” for more energy efficient building services. Whilst energy efficient building services are always desirable, the energy efficiency of a building’s envelope is of greater importance. Services may change over time or a lack of maintenance may cause the services to under-perform.

On the other hand, once the passive energy efficiency requirements for the envelope are in place, they generally maintain their performance for the life of the building, which will exceed the life of the services. Services are also typically easier and more cost-effective to upgrade in comparison to the building fabric.

Table 4.37 outlines the key requirements for J1V3 for the common areas of an apartment building.

Table 4.37 Key requirements for J1V3 for the common areas of an apartment building

Clause J1V3 reference	Key requirements
(1)(a) and (b) GHG emissions and PMV	<ul style="list-style-type: none"> • The annual GHG emissions of the proposed building are not more than the annual GHG emissions of a reference building when: <ul style="list-style-type: none"> – the proposed building is modelled with the proposed services – the proposed building is modelled with the same services as the reference building. • The common areas of a proposed apartment building must provide a thermal comfort level of between a Predicted Mean Vote (PMV) of -1 to +1 across not less than 95% of the floor area of all occupied zones • The thermal comfort level must be demonstrated for not less than 98% of the annual hours of operation of the building



Clause J1V3 reference	Key requirements
(1) Additional requirements	<ul style="list-style-type: none"> The building must comply with the additional requirements in Specification 33 (refer to Table 4.38 below)
(5) Renewable and reclaimed energy	<ul style="list-style-type: none"> The annual greenhouse gas emissions of the proposed building may be offset by: <ul style="list-style-type: none"> renewable energy generated and used on site another process such as reclaimed energy, used on site.
(2) Calculation method	<ul style="list-style-type: none"> The calculation method used for (1) and (2) must comply with: <ul style="list-style-type: none"> ANSI/ASHRAE Standard 140 Specification 34.

4.4.2.1 Additional requirements

In addition to the modelling requirements specified in J1V3, a building must comply with the requirements specified in S33C2. A summary of the additional requirements is shown in Table 4.38.

Table 4.38 Additional requirements from Specification 33

S33C2 reference	NCC reference/requirement
(a) General thermal construction	<ul style="list-style-type: none"> J4D3
(b) Floor edge insulation	<ul style="list-style-type: none"> J4D7(2) and J4D7(3)
(c) Building sealing	<ul style="list-style-type: none"> J1V4 or Part J5
(d) Air-conditioning and mechanical ventilation systems	Covers deactivation, control and insulation <ul style="list-style-type: none"> J6D3(1)(a), J6D3(1)(b)(i) J6D3(1)(d), J6D3(1)(f) J6D3(2) and (3) J6D4(2) and (4) J6D5, J6D6 and J6D9
(e) Packaged air-conditioning equipment	<ul style="list-style-type: none"> Applies to equipment not less than 65 kW_r AS/NZS 3823.1.2 at test condition T1



S33C2 reference	NCC reference/requirement
(f) Refrigeration system	<ul style="list-style-type: none">Applies to testing a refrigeration chillerAHRI 551/591
(g) Interior artificial lighting and power control	<ul style="list-style-type: none">J7D4
(h) Interior decorative and display lighting	<ul style="list-style-type: none">J7D5
(i) Artificial lighting around the exterior of a building	<ul style="list-style-type: none">J7D6
(j) Boiling water and chilled water storage units	<ul style="list-style-type: none">J7D7
(k) Deactivation of swimming pool heating and pumping	<ul style="list-style-type: none">J8D3(2)(b) and J8D3(3)
(l) Deactivation of spa pool heating and pumping	<ul style="list-style-type: none">J8D4(2)(b) and J8D4(3)
(m) Facilities for energy monitoring	<ul style="list-style-type: none">Part J9
(n) Deactivation of fixed outdoor space heating appliances	<ul style="list-style-type: none">J6D10(3)

4.4.2.2 Calculation method

As indicated in J1V3, the calculation method used for J1V3(1) and (2) must comply with ANSI/ASHRAE Standard 140. ANSI/ASHRAE Standard 140 provides a consistent test method for the evaluation of building analysis computer programs.

The calculation method must also comply with Specification 34, which outlines the modelling parameters for J1V3.

Alert:

ANSI/ASHRAE Standard 140 2007 is the Standard Method of test for the Evaluation of Building Energy Analysis Computer Programs. ANSI/ASHRAE Standard 140 specifies test procedures for evaluating the technical capabilities of software used to calculate the thermal performance of buildings and their HVAC systems.

4.4.2.3 Modelling parameters and profiles

Clause 3 of Specification 34 specifies the parameters used for modelling the proposed building and reference building, to ensure a fair and equal comparison of parameters between the 2 building models. In general, the annual GHG emissions value for J1V3(1) and (2) must be calculated using the same parameters as outlined in S34C3(1)(a) to (i) for common areas of the proposed building and reference building.



The key requirements that must be the same in both modelling runs and the associated clause reference is in Table 4.39.

Table 4.39 Key modelling parameter requirements for both models using J1V3 VURB

Parameters that must be used to calculate annual GHG emissions for both models	NCC reference(s)
Annual GHG emissions calculation method	S34C3(1)(a)
GHG emissions factors	S34C3(1)(b) and (2) Table S34C3
Location	S34C3(1)(c) and (3)
Adjacent structures and features	S34C3(1)(d)
Orientation	S34C3(1)(e)
Building form including: <ul style="list-style-type: none"> • roof geometry • floor plan • number of storeys • location • extent and configuration of ground floors and basements • the size and location of glazing • external doors. 	S34C3(1)(f) and (4)
Fabric and glazing including insulation, thermal resistance of air films, internal shading devices, and external, internal and separating walls	S34C3(5)
Services (and profiles), including air-conditioning control and services, floor coverings, furniture, fittings, internal heat gains (i.e. people, lighting, appliances, meals and other appliances), energy sources ³⁹	S34C3(6) Specification 35 Table S34C3
Services – system demand and response	S34C4(a)

³⁹ Not including renewable energy generated on-site.

**Parameters that must be used to calculate annual GHG emissions for both models****NCC reference(s)**

Services – energy usage

S34C4(b) to (i)

Profiles for occupancy, air-conditioning, lighting and internal heat gains (i.e. from people, hot meals, appliances, equipment and heated water supply systems) need to be modelled as part of the calculation of the annual GHG emissions. Options for generating these profiles are outlined at S34C3(6)(g).

One of these options includes Specification 35 Modelling profiles for J1V3. This specification contains modelling profiles that can be used as part of the calculation for modelling the proposed and reference building. Table 4.40 outlines the modelling profiles in Specification 35.

Table 4.40 Key modelling requirements for both models (reference and proposed) using J1V3 VURB

Model profile required	NCC reference(s)
Air-conditioning – Daily occupancy and operation profiles	S35C2(1)(a), Table S35C2a
Air-conditioning – Internal heat gains in a building	S35C2(b), Tables S35C2n and S35C2l
Artificial lighting	S35C2(2), Table S35C2a
Heated water supply	S35C2(3), Table S35C2m

4.4.2.4 Renewable energy

J1V3 allows on-site renewable energy resources and re-claimed energy from another process to be deducted from the annual GHG emissions of the proposed building. This means that the annual GHG emissions represent the sum of the GHG emissions drawn annually from the electrical grid, the gas network or fuel brought in by road transport and not the total of the energy consumed by the services that use energy.

To obtain this concession, the renewable energy must be used and generated on-site. This means that electricity purchased as GreenPower for example does not comply with the concession as it is grid distributed. Energy that is exported to the grid cannot be used as part of this concession.

In determining the amount of renewable energy, a designer needs to consider the likely availability of energy from the resources, including any down time the plant equipment may experience for maintenance.

Examples of reclaimed energy could be the waste heat captured to heat water from a refrigeration chiller (rather than being rejected to a cooling tower); or energy from a process



unrelated to building services, such as steam condensate from a laundry process. Note that co-generation and tri-generation systems are excluded from providing any credit; as they are considered a service in their entirety, rather than a subsequent energy gain from a system already in place.

4.4.3 Useful tips

- As with J1V1 and J1V2, J1V3 requires the thermal comfort level in the proposed building to be between a PMV of -1 to +1 across at least 95 percent of the floor area of all occupied zones for at least 98 percent of the hours of operation. A PMV of -1 to +1 means that 75% of people are satisfied and comfortable. Note, this is likely to be appropriate for buildings that meet the applicability criterion in Section 5.4.1 of ASHRAE 55-2013.
- The PMV metric is designed for fully mechanically ventilated buildings. If a building is either mixed-mode or naturally ventilated, the Adaptive Thermal Comfort metric may be more appropriate. The Adaptive Thermal Comfort metric relates indoor design temperatures to outdoor temperatures (i.e. higher room temperatures during warmer weather) based on the understanding that occupants can adapt to, or even prefer a wider range of conditions. This can be used as a Performance Solution subject to the approval of the Appropriate Authority.

4.4.4 Demonstrating compliance

4.4.4.1 Background

A Performance Solution can be used in an individual situation where the desired solution meets the Performance Requirements of the NCC, but not the relevant DTS Provisions. These solutions are often flexible in achieving the outcomes required and encourage innovative design and technology use.

Demonstrating compliance with the Performance Requirements may utilise one of more of the NCC Assessment Methods. These are evidence of suitability, Expert Judgement; Verification Methods and Comparison to DTS. An overview of how to demonstrate compliance with the NCC is in Appendix C of this document, with further guidance available from the [ABCBC website](#).

J1V3 is an NCC Verification Method and therefore can form part of a Performance Solution. More information on NCC Assessment Methods is provided by the resource, Understanding the NCC – Assessment Methods, which is available from the [ABCBC website](#).



Reminder

'Verification Method' is an NCC defined term and means a test, inspection, calculation, or other method that determines whether a Performance Solution complies with the relevant Performance Requirements.

4.4.4.2 Performance Solution process

To help ensure a Performance Solution provides the level of intended performance, Clause A2G2(4) of the NCC mandates a process for developing Performance Solutions. This process must be followed regardless of whether the Performance Solution is simple or complex in nature. The 4 steps of the Performance Solution process include:

- (1) preparing a brief
- (2) carrying out analysis
- (3) evaluating results
- (4) preparing a final report.

More information is provided in the Performance Solution Process Guidance Document and the ABCB Performance Solution Process Handbook, which are available from the [ABCBC website](#).

4.4.4.3 Professional practice and ethics

Some state and territory legislation empowers certain practitioners to develop and/or approve Performance Solutions. Irrespective of controls about who can undertake this process, the practitioners involved have a professional responsibility for ensuring that appropriately skilled and experienced persons are engaged and participate as stakeholders in the process.

When preparing a Performance Solution, practitioners should exercise their duties in an appropriate manner. Key principles include:

- **Acting in the public interest:** In undertaking their duties, a practitioner should exercise their discretionary powers in ways that safeguard the public interest. A practitioner's consideration of the interests of their clients and employers must not be contrary to the public interest.
- **Independence:** In performing their professional duties, a building surveyor/certifier should be objective, impartial and conduct themselves in accordance with the relevant requirements of state and territory legislation. Other practitioners should ensure any conflicts of interest are disclosed to all relevant parties.
- **Competence:** A practitioner should not undertake professional work that they are not competent to perform.



4.4.4.4 Examples

An example of using J1V3 VURB is provided in [Appendix E.5](#).



4.5 Compliance Option 5: J1V4 Verification of building envelope sealing

4.5.1 Introduction

J1V4 Verification of building envelope sealing is a Verification Method that can be used as part of a Performance Solution to assess if a proposed solution for an apartment building complies with the Performance Requirement J1P1(e) for building envelope sealing, and J1P2.

Compared to NCC 2019, the main change to this compliance option for NCC 2022 is the inclusion of mechanical ventilation requirements for an SOU. This is because a tightly sealed SOU requires mechanical ventilation to manage indoor moisture and air quality.

4.5.2 Method

The intent of this method is to provide a means of verifying compliance with the thermal Performance Requirements of J1P1(e) and J1P2 for building envelope sealing through practical testing.

The key requirements of this Verification Method in relation to the common areas of an apartment building are summarised in Table.4.41.

Table.4.41 Key requirements of Verification of building envelope sealing

J1V4 reference	Key requirements
(1)(a) Overall criteria for apartment buildings	<ul style="list-style-type: none">• An apartment building must be sealed to an air permeability less than or equal to 10 m³/hr.m² at 50 Pa reference air pressure• Tested using Method 1 of AS/NZS ISO 9972
(2) Additional ventilation requirements	<ul style="list-style-type: none">• Solid-fuelled appliances must be ventilated with permanent openings directly to outside• Gas-fuelled appliances must be ventilated in accordance with clauses 6.4 and 6.4.5 of AS/NZS 5601.1
(3) Note	<ul style="list-style-type: none">• The volume of space for determining ventilation requirements for gas-fuelled appliances is 1 m³



Alert

AS/NZS ISO 9972 is the Australian/New Zealand standard, “Thermal performance of buildings – Determination of air permeability of buildings – Fan pressurization method”.

This standard contains requirements for testing the air permeability of buildings using the fan pressurisation method, including the apparatus, measurement procedures, expression of results and the standardised format of testing reports.

There are 3 different methods contained within the standard. However, Method 1 must be used for the purposes of Verification Method J1V4.

4.5.3 Useful tips

- Verification Method J1V4 is limited to Performance Requirement J1P1(e) for building envelope sealing and cannot verify compliance with any other components of J1P1.
- The DTS Provisions for building sealing in Part J5, can be used as guidance prior to testing commencing.
- Temporary envelope sealing (except for that within the testing procedure) is not appropriate, as the tested scenario must represent the final building.
- This verification testing should be planned in the program of a build, to ensure that the requirement can be demonstrated, and improvements made after testing if required.
- Air infiltration rates are determined for all windows tested to AS 2047 and are published on the [WERS](#) website. The selection of windows with a low air infiltration rate should be considered to assist complying with the criteria in Verification Method J1V4.
- Method 1 within AS/NZS ISO 9972 precisely defines the testing requirements, so refer to the standard to confirm the requirements for your specific project.
- When designing a building, both Performance Solutions and DTS Solutions can be used to achieve compliance with the Performance Requirements. A combination of both Performance and DTS Solutions may also be used to satisfy a single Performance Requirement. This may include occasions where a specific Performance Requirement covers several elements of a building. This is the case for Performance Requirement J1P1 for the thermal performance of an apartment building. Therefore, it is possible to use the J1V4 Verification Method that covers building sealing in a combination with the DTS Provisions that form part of the Elemental compliance option for the remainder of the building elements for the common areas of the apartment building. See Part A2 of NCC Volume One for more information.



4.5.4 Demonstrating compliance

4.5.4.1 Background

A Performance Solution can be used in an individual situation where the desired solution meets the Performance Requirements of the NCC, but not the relevant DTS Provisions. These solutions are often flexible in achieving the outcomes required and encourage innovative design and technology use.

Demonstrating compliance with the Performance Requirements may utilise one or more of the NCC Assessment Methods. These are evidence of suitability, Expert Judgement; Verification Methods and Comparison to DTS. An overview of how to demonstrate compliance with the NCC is in Appendix C of this document, with further guidance available from the [ABCB website](#).

Verification of building envelope sealing is an NCC Verification Method and therefore part of a Performance Solution. More information on NCC Assessment Methods provided in the resource, Understanding the NCC – Assessment Methods, which is available from the [ABCB website](#).

Reminder

‘Verification Method’ is an NCC defined term and means a test, inspection, calculation or other method that determines whether a Performance Solution complies with the relevant Performance Requirements.

4.5.4.2 Performance Solution process

To help ensure a Performance Solution provides the level of intended performance, Clause A2G2(4) of the NCC mandates a process for developing Performance Solutions. This process must be followed regardless of whether the Performance Solution is simple or complex in nature.

The 4 steps of the Performance Solution process include:

- preparing a brief
- carrying out analysis
- evaluating results
- preparing a final report.

More information on this process is in the Performance Solution Process Guidance Document and the ABCB Performance Solution Process Handbook, which are available from the [ABCB website](#).

4.5.4.3 Professional practice and ethics

Some state and territory legislation empowers certain practitioners to develop and/or approve Performance Solutions. Irrespective of controls about who can undertake this process, the



practitioners involved have a professional responsibility for ensuring that appropriately skilled and experienced persons are engaged and participate as stakeholders in the process.

When preparing a Performance Solution, practitioners should exercise their duties in an appropriate manner. Key principles include:

- Acting in the public interest - In undertaking their duties, a practitioner should exercise their discretionary powers in ways that safeguard the public interest. A practitioner's consideration of the interests of their clients and employers must not be contrary to the public interest.
- Independence - In performing their professional duties, a building surveyor/certifier should be objective, impartial and conduct themselves in accordance with the relevant requirements of state and territory legislation. Other practitioners should ensure any conflicts of interest are disclosed to all relevant parties.
- Competence - A practitioner should not undertake professional work that they are not competent to perform.

4.5.5 Example

To assist with the use of J1V4 Verification of building envelope sealing, an example is in [Appendix D.7](#).



4.6 Compliance Option 6: Other Performance Solutions

4.6.1 Introduction

As outlined in Chapter 2, there are 3 options available to demonstrate compliance with the Performance Requirements:

- a Performance Solution
- a DTS Solution, or
- a combination of a Performance Solution and a DTS Solution.

An overview of how to comply with the NCC is in Appendix C of this document, with further guidance available from the [ABCBC website](#).

A Performance Solution can be used in an individual situation where the desired solution meets the Performance Requirements of the NCC, but not the relevant DTS Provisions. These solutions are often flexible in achieving the outcomes required and encourage innovative design and technology use.

Compliance with the energy efficiency Performance Requirements for the common areas of an apartment building - J1P1 Energy use and J1P4 Renewable energy and electric vehicle charging - need to be achieved. Any proposed Performance Solution needs to demonstrate that this has been achieved.

This section outlines some potential options for Performance Solutions that do not use an NCC Verification Method as the Assessment Method.

Reminder

A key principle underpinning the NCC 2022 apartment energy efficiency requirements is that all compliance options aim to offer an equivalent level of performance. This principle helps ensure the policy objectives set out in Objective J1O1 (see section 2.2) are achieved.

4.6.2 Assessment Methods

Assessment Methods are used when determining if a Performance Solution complies with the relevant Performance Requirements.

The following Assessment Methods are listed in the NCC (see A2G2 and A2G3) and each, or any combination, can be used to demonstrate compliance for a Performance Solution where appropriate:

- Evidence of suitability



- Expert Judgement
- Comparison with the DTS Provisions
- Verification Methods.

These Assessment Methods are discussed in the following sections.

4.6.2.1 Evidence of suitability

Evidence of suitability, also known as ‘documentary evidence’, can generally be used to support that a material, product, form of construction or design satisfies a Performance Requirement. Subject to certain NCC provisions, the form of evidence that may be used consists of one, or a combination, of the following:

- A report from an Accredited Testing Laboratory.
- A Certificate of Conformity or a Certificate of Accreditation.
- A certificate from a professional engineer or appropriately qualified person.
- A current certificate issued by a product certification body that has been accredited by the JAS-ANZ.
- Any other form of documentary evidence that adequately demonstrates suitability such as a Product Technical Statement.

More information on this Assessment Method is available in the ABCB Evidence of Suitability Handbook (2021).

In relation to apartment energy efficiency, individual jurisdictions may have issued specific directions or notices specifying what documentary evidence is considered acceptable to demonstrate compliance.

4.6.2.2 Expert Judgement

Where physical criteria is unable to be tested, or modelled by calculation, the opinion of an expert may be accepted. Expert Judgment is the judgement of a person who has the qualifications and experience necessary to determine whether a Performance Solution complies with the Performance Requirements.

It is the role of the appropriate authority to determine whether a person providing an Expert Judgement is considered an expert.

More information on the use of Expert Judgement, including guidance on who may be considered an expert, is in the resource Understanding the NCC – Assessment Methods, which is available from the [ABCB website](https://www.abcb.gov.au).

The energy efficiency of an apartment building design is readily determined by verifiable means; therefore, Expert Judgement is inappropriate as a sole Assessment Method for assessing a Performance Solution for compliance with J1P1 and J1P4.



4.6.2.3 Comparison with the DTS Provisions

This Assessment Method involves a comparative analysis demonstrating that a Performance Solution is better than, or at least equivalent to, a solution that complies with the relevant DTS Provision(s).

To carry out this comparison, the applicable DTS Solution and Performance Solution both need to be subject to the same level of analysis using the same methodology. This provides the building designer and appropriate authority with a defined benchmark or level for the DTS Solution and the Performance Solution.

The intent of J1V3 Verification using a reference building is to provide a pathway that utilises the principle underpinning the Comparison with the DTS Provisions Assessment Method, in that the outcome must be better than, or at least equivalent to, a DTS Solution. This is achieved using a reference apartment building (common areas only) and a proposed apartment building (common areas only). The method provides a set of reasonable assumptions, parameters and exclusions to help ensure a Performance Solution produced using this Verification Method provides the intended level of performance.

Therefore, it is expected that a Performance Solution that uses a Comparison with the DTS Provisions Assessment Method would use a similar set of reasonable assumptions, parameters and exclusions to those specified in J1V3. The parameters, assumptions, exclusions, calculation methodology and acceptance criteria would also need to be agreed by relevant stakeholders as required by the Performance Solution Process.

4.6.2.4 Verification Methods

Verification Methods are tests or calculations that prescribe a way to assess compliance with relevant NCC Performance Requirements. They include a test, inspection, calculation, or a combination of these.

Verification Methods not contained in the NCC may be used if deemed suitable by the appropriate authority.

4.6.3 Performance Solution Process

To help ensure a Performance Solution provides the level of intended performance, clause A2G2(4) of the NCC mandates a process for developing Performance Solutions. This process must be followed regardless of whether the Performance Solution is simple or complex in nature.

The 4 steps of the Performance Solution process include:

- (1) preparing a brief
- (2) carrying out analysis
- (3) evaluating results
- (4) preparing a final report.



More information on this process is in the Performance Solution Process Guidance Document and the ABCB Performance Solution Process Handbook, which are available from the [ABCB website](#).

4.6.3.1 Quantified Performance Requirements

The incorporation of energy targets into J1P1 (Energy use) provides a quantified compliance pathway for the common areas of an apartment building that are air-conditioned to meet this Performance Requirement. J1P1 incorporates targets for the energy use of a building in units of kilojoules per square metre of conditioned space per hour (kJ/m².hr) of building operation, averaged over the course of a year. The quantified energy targets are only applicable to conditioned spaces.

J1P1 provides an absolute performance target for the energy use of air-conditioned buildings. This approach is intended to ensure that designers have a pure performance target and are thereby free to innovate across all aspects of design.

However, unconditioned spaces such as carparks (Class 7a) attached to an apartment building (Class 2) will not be able to fully use a direct Performance Solution for J1P1 - they are limited to Performance Solutions based on the unquantified elements of J1P1.

Performance Solutions that use either the quantified or unquantified elements of J1P1 both need to use the Performance Solution process described in section 4.6.3.

For step 1 of the Performance Solution process, a performance-based design brief (PBDB) needs to be developed. The purpose of the brief is to record the fundamental activities and outcomes of the Performance Solution development, as agreed by stakeholders. The PBDB must include the acceptance criteria for the proposed Performance Solution, which often requires accounting for the location and characteristics of the building.

4.6.4 Professional Practice and Ethics

Some state and territory legislation empowers certain practitioners to develop and/or approve Performance Solutions. Irrespective of controls about who can undertake this work, the practitioners involved have a professional responsibility for ensuring that appropriately skilled and experienced persons are engaged to develop and approve Performance Solutions.

When preparing a Performance Solution, practitioners should exercise their duties in an appropriate manner. Key principles include:

- **Acting in the public interest:** In undertaking their duties, a practitioner should exercise their discretionary powers in ways that safeguard the public interest. A practitioner's consideration of the interests of their clients and employers must not be contrary to the public interest.



- Independence: In performing their professional duties, a building surveyor/certifier should be objective, impartial and conduct themselves in accordance with the relevant requirements of state and territory legislation. Other practitioners should ensure any conflicts of interest are disclosed to all relevant parties.
- Competence: A practitioner should not undertake professional work that they are not competent to perform.

Appendices



Appendix A Abbreviations

The following table, Table A.1 contains abbreviations used in this document.

Table A.1 Abbreviations

Abbreviation	Meaning
AAOs	Assessor Accrediting Organisations
ABCB	Australian Building Codes Board
AFRC	Australian Fenestration Rating Council
AHRI	Australian Human Resources Institute
ANSI	American National Standards Institute
AS	Australian Standard
ASHRAE	American Society of Heating, Refrigerating and Air-Conditioning Engineers
BASIX	Building Sustainability Index
BCA	Building Code of Australia
CIBSE	Chartered Institution of Building Services Engineers
CSIRO	Commonwealth Scientific and Industrial Research Organisation
CSOG	Concrete slab-on-ground
DIN	Deutsches Institut für Normung (German Institute for Standardization)
DTS	Deemed-to-Satisfy
EEI	Energy efficiency index
EPW	EnergyPlus Weather File
EV	Electric vehicle
FDCIE	Fire Detection Indicator Control Equipment
GEMS	Greenhouse and Energy Minimum Standards
GHG	Greenhouse gas
HEPA	High efficiency particulate arrestance
HVAC	Heating ventilation and air-conditioning
ISO	International Standardization Organisation
JAS-ANZ	Joint Accreditation System of Australia and New Zealand



Abbreviation	Meaning
LED	Light emitting diode
MEPS	Minimum Energy Performance Standards
NABERS	National Australian Built Environment Rating System
NatHERS	Nationwide House Energy Rating Scheme
NCC	National Construction Code
NZS	New Zealand Standard
PBDB	Performance-based Design Brief
PCA	Plumbing Code of Australia
PMV	Predicted mean vote
PV	Photovoltaic
SA	Solar absorptance
SHGC	Solar heat gain coefficient
SOU	Sole-occupancy unit
VURB	Verification using a reference building
WERS	Window Energy Rating Scheme
WHS	Workplace Health & Safety
WOH	Whole-of-home (NCC) Whole of Home (NatHERS)
ZERL	Zoned energy rating label



Appendix B Glossary

This appendix contains a glossary of key terms used in this document with links to further information where relevant.

The glossary includes NCC extracts of defined terms. These are identified by the following document style below.

NCC extracts⁴⁰

Air barrier: A layer used to restrict the movement of air under the normal pressure differences found across building elements⁴¹.

More information is available from the ABCBC Condensation in buildings Handbook which is available from the [ABCBC website](#).

Air-conditioning: For the purposes of Section J of Volume One, a service that actively cools or heats the air within a space, but does not include a service that directly—

- (a) cools or heats cold or hot rooms; or
- (b) maintains specialised conditions for equipment or processes, where this is the main purpose of the service.

Air infiltration: The unintended movement of outside air into a building through gaps, cracks and penetrations in the building structure.

The DTS Provisions for building sealing in Part J5 Building sealing of Volume One aim to minimise air infiltration.

Air exfiltration: The unintended movement of indoor air out of a house building through gaps, cracks and penetrations in the building structure.

The DTS Provisions for building sealing in Part J5 Building sealing of Volume One aim to minimise air exfiltration. See section 3.4 and section 4.5 for more information.

Air movement: The movement of air for the purpose of cooling that is created either through natural forces (i.e. openings, vents) or mechanical power (i.e. fans).

Performance Requirement J1P2 considers the benefits of air movement for cooling through:

- (1) the openability of windows in the calculation of acceptable summer heat gain through windows (glazing), and
- (2) by requiring ceiling fans in hot and warm climate zones.

⁴⁰ NCC extracts italicise defined terms as per the NCC. See Schedule 1 of the NCC for further information.

⁴¹ ABCBC (2023) Condensation in buildings handbook, ABCBC, accessed Jan 2023.



Air permeability: The tested rate of air infiltration and air exfiltration in $\text{m}^3/\text{hr.m}^2$ for a house measured using a blower door test at a 50 Pa reference pressure.

See J1V4 Verification building envelope sealing (section 3.4 and section 4.5).

Amenity: An attribute which contributes to the health, physical independence, comfort and well-being of people.

services

Artificial cooling: The cooling of an indoor air space using air-conditioning, not including passive cooling⁴².

More information is available from [YourHome](#).

Artificial heating: The heating of an indoor air space using air-conditioning, not including passive heating⁴³.

Assessment Method: A method that can be used for determining that a *Performance Solution* or *Deemed-to-Satisfy Solution* complies with the *Performance Requirements*.

More information on Assessment Methods is in the resource Understanding the NCC – Assessment Methods, which is available from the [ABCBC website](#).

Building element: The major functional parts of the building envelope such as roof, walls and floors.

Building sealing: To limit air infiltration and exfiltration through the building envelope by caulking, sealing, weather-stripping, or using dampers. The tighter the building is sealed; the less air infiltration and exfiltration occurs. This can help with lowering the heating and cooling load of a house and reduce the use of artificial heating or cooling.

Bulk insulation: Bulk insulation includes glass fibre, wool, cellulose fibre, polyester, wood fibre and polystyrene foam. These materials have a high percentage of air voids that provide thermal resistance to heat flow⁴⁴, i.e. limits conduction. In some cases, the material itself may provide significant thermal resistance, e.g. cellulose.

More information is available from [YourHome](#).

Cavity: A void between 2 leaves of masonry, or in masonry veneer construction, a void between a leaf of masonry and the supporting frame.

⁴² YourHome, [Passive cooling](#), accessed September 2023.

⁴³ YourHome, [Passive heating](#), accessed September 2023.

⁴⁴ YourHome, [Insulation](#), accessed September 2023.



Typically, a cavity is a minimum void of 35 mm between 2 leaves of masonry, or in masonry veneer construction, the void between a leaf of masonry and the supporting frame.

Climate zone: Climate zone means an area defined in Figure 2 and in Table 3 of the NCC Glossary for specific locations, having energy efficiency provisions based on a range of similar climatic characteristics.

The NCC specifies 8 climate zones for thermal design. There are also 69 regional subzones that are defined and used by NatHERS.

Commitment Agreement: A Commitment Agreement is a contract signed by a developer or owner to commit to design, build and commission a building to achieve a specific NABERS energy rating⁴⁵.

Condensation: The formation of moisture on the surface of a building element or material as a result of moist air coming into contact with a surface which is at a lower temperature.

More information on condensation management in the NCC is available in the ABCB's handbook, *Condensation in Buildings (2023)*, which is available from the [ABCB website](#).

Conditioned space: For the purposes of—Volume One, a space within a building, including a ceiling or under-floor supply air plenum or return air plenum, where the environment is likely, by the intended use of the space, to have its temperature controlled by *air-conditioning*

(b) ...

Conduction: The process of heat transfer from one material to another by direct contact of the materials. A simple example of conduction is the transfer of heat from a stovetop to a metal pot.

Cooling load: The calculated amount of energy removed from the cooled spaces of the building annually by artificial means to maintain the desired temperatures in those spaces.

Cooling loads can be controlled by limiting the amount of heat that enters a building or air circulating into or out of the building through air infiltration and exfiltration.

Cooling loads are regulated by Performance Requirement J1P2 and the associated compliance options outlined in Section 2.4. These compliance options include:

- NatHERS energy rating (Section 3.1)
- Elemental provisions (Section 3.2)
- VURB (Section 3.3)
- First principles (Section 3.5).

⁴⁵ www.nabers.gov.au



Reminder

The heating load, cooling load and total thermal energy load limits specified by J1P2 and associated compliance options, are not the same as the actual amount of energy used for heating and cooling.

The amount of energy used for heating and cooling depends on the source of the energy used (i.e. fuel type) and the efficiency of the heating and cooling equipment.

The amount of energy used for heating and cooling is regulated by J1P3.

Cross-ventilation: A natural method of cooling an SOU by allowing cool air in and hot air out through openings such as windows⁴⁶. Cross-ventilation is a technique used in passive cooling. Window open-ability can be varied to account for the benefits of cross-ventilation. Cross-ventilation is considered in the external glazing requirements in section 3.2.2.3 of this document.

Deemed-to-Satisfy Provisions: Provisions which are deemed to satisfy the *Performance Requirements*.

The DTS Provisions are prescriptive (i.e. like a recipe book, they tell you how, what and in which location things must be done). They include materials, components, design factors, and construction methods that, if used, are deemed to meet the Performance Requirements, hence the term 'Deemed-to-Satisfy'.

Deemed-to-Satisfy Solution: A method of satisfying the *Deemed-to-Satisfy Provisions*.

A DTS Solution is achieved by following all appropriate DTS Provisions in the NCC.

Distributed energy resources: Distributed energy resources (DER) refers to smaller energy generation units that are located on the consumer's side of the meter. Examples of DER that can be installed are roof top solar PV panels, battery storage and batteries in electric cars used to export power back to the grid. It also includes combined heat and power units that use waste heat to provide cooling⁴⁷.

⁴⁶ YourHome, [Glossary](#) (2020), YourHome, accessed Oct 2022.

⁴⁷ www.aemc.gov.au.



Domestic services: The basic engineering systems that use energy or control the use of energy; and—includes—

- (i) heating, *air-conditioning*, mechanical ventilation and artificial lighting; and
 - (ii) pumps and heaters for *swimming pools* and spa pools; and
 - (iii) heated water systems; and
 - (iv) on-site *renewable energy* equipment; but
- (b) excludes cooking facilities and portable appliances.

The definition of domestic services excludes portable appliances. This means the definition of domestic services excludes plug-in appliances such as like fridges, dishwashers, clothes washers and microwaves.

Elemental provisions: DTS Provisions that require each element or part of a proposed building to meet a minimum level of thermal performance or efficiency. For example, the floors, walls, glazing and roof.

Energy value: The net cost to society including, but not limited to, costs to the building user, the environment and energy networks.

Energy value is the economic or societal cost (or cost savings) associated with on-site energy usage or generation. It is primarily based on:

- energy prices
- impacts of pollution and GHG emissions⁴⁸
- impacts on energy networks.⁴⁹

This term is used in the Performance Requirement J1P3 to set the level of stringency for the energy use from the domestic services in an SOU of a Class 2 apartment building.

Energy efficiency: To minimise the use of energy for heating, cooling, heated water, lighting, pool pumps and heating services by improving the efficiency of appliances or minimising heat flow through building fabric.

Energy efficiency index (EEI): EEI is a characteristic of a pump. The lower the EEI, the less energy the pump uses. EEI is calculated in accordance with European Union Commission Regulation No. 622/2012.

⁴⁸ The costs to the environment were determined per tonne of GHG emissions.

⁴⁹ The costs to the energy network were determined using a time of use tariff.



Energy peak demand: The time of day where a building's energy consumption is at its highest. It can also mean the period(s) during a year where a building's energy consumption is at its highest.

Energy source: The type of energy used for domestic services, such as electricity, gas, wood or solar power⁵⁰.

Envelope: For the purposes of—

- (a) Section J in NCC Volume One, the parts of a building's fabric that separate a conditioned space or (a)habitable room from—
 - (i) the exterior of the building; or
 - (ii) a non-conditioned space including—
 - (A) floor of a rooftop plant room, lift-machine room or the like; and
 - (B) the floor above a carpark or warehouse; and
 - (C) the common wall with a carpark, warehouse or the like; or
- (b) ...

Expert Judgement: The judgement of an expert who has the qualifications and experience to determine whether a *Performance Solution* or *Deemed-to-Satisfy Solution* complies with the *Performance Requirements*.

Contemporary and relevant qualifications and/or experience are necessary to determine whether a Performance Solution complies with the Performance Requirements. The level of qualification and/or experience may differ depending on the complexity of the proposal and the requirements of the regulatory authority.

Practitioners should seek advice from the authority having jurisdiction or appropriate authority for clarification as to what will be accepted.

External wall: For the purposes of—

- (a) Volume One, an outer wall of a building which is not a *common wall*; or
- (b) ...

Evaporative cooling: Evaporative cooling is a type of passive cooling that uses evaporated water to cool hot air.

Fabric: The basic building structural elements and components of a building including the roof, ceilings, walls, glazing and floors.

⁵⁰ YourHome, [Energy](#) (2020), YourHome, accessed 2022.



Floor area: For the purposes of—

- (1) Volume One
 - (a) in relation to a building — the total area of all storeys; and
 - (b) in relation to a storey — the area of all floors of that storey measured over the enclosing walls, and includes—
 - (i) the area of a mezzanine within the storey, measured within the finished surfaces of any external walls; and
 - (ii) the area occupied by any internal wall or partitions, any cupboard, or other built-in furniture, fixture or fitting; and
 - (iii) if there is no enclosing wall, an area which has a use that contributes to the *fire load* or impacts on the safety, health or amenity of the occupants in relation to the provisions of the BCA; and
 - (c) in relation to a room — the area of the room measured within the internal finished surfaces of the walls, and includes the area occupied by any cupboard or other built-in furniture, fixture or fitting; and
 - (d) in relation to a fire compartment — the total area of all floors within the fire compartment measured within the finished internal surfaces of the bounding construction, and if there is no bounding construction, includes an area which has a use which contributes to the fire load; and
 - (e) in relation to an atrium — the total area of all floors within the atrium measured within the finished surfaces of the bounding construction and no bounding construction, within the external walls.
- (2) ...

Functional statement: A non-mandatory statement providing guidance on how buildings and building elements achieve the Objectives. The Functional Statement for apartment building energy efficiency is in the introduction of NCC Volume One Part J1F1 and discussed in Chapter 2.

GEMS: The Greenhouse and Energy Minimum Standards (GEMS) set out the minimum energy efficiency requirements that specific types of products must meet before they can be supplied in Australia⁵¹.

⁵¹ www.energyrating.gov.au



Glazing: For the purposes of—

- (a) Section J of Volume One, except for a *sole-occupancy unit* of a Class 2 building or a Class 4 part of a building—
 - (i) a transparent or translucent element and its supporting frame located in the *envelope*; and
 - (ii) includes a *window* other than a *roof light*; or
- (b) Section J of Volume One, for a *sole-occupancy unit* of a Class 2 building or a Class 4 part of a building—
 - (i) a translucent element and its supporting frame located in the external fabric of the building; and
 - (ii) includes a window other than a *roof light*; or
- (c) ...

Governing Requirements: These are the mandatory rules and instructions for using and complying with the NCC. They are in Section A of NCC Volumes One, Two and Three.

The Governing Requirements explain important concepts on how the NCC must be interpreted and applied. There are certain conventions and approaches that need to be taken into account when using the NCC, such as interpreting specific language and terms. This is critical to understanding the intended technical and legal meaning of the NCC.

The Governing Requirements also explain the difference between the mandatory parts of the NCC and the parts that are only explanatory or guidance in nature.

Habitable room: A room used for normal domestic activities, and—

- (a) includes a bedroom, living room, lounge room, music room, television room, kitchen, dining room, sewing room, study, playroom, family room, home theatre and sunroom; but
- (b) excludes a bathroom, laundry, water closet, pantry, walk-in wardrobe, corridor, hallway, lobby, photographic darkroom, clothes-drying room, and other spaces of a specialised nature occupied neither frequently nor for extended periods.

Heated water: Water that has been intentionally heated; normally referred to as hot water or warm water.



Greenhouse gas: The atmospheric gases responsible for causing climate change⁵². More information is available from [YourHome](#).

Green Star: The building sustainability rating scheme managed by the Green Building Council Australia⁵³.

Gross thermal efficiency: The total amount of heat produced through the burning of gas (or oil).

Heat flow: The movement of heat (energy). Heat flows from hot objects to cool objects through the processes of conduction, convection and radiation.

For example, in cold climates heat flows from indoors to outdoors.

Heating load: The calculated amount of energy delivered to the heated spaces of the building annually by artificial means to maintain the desired temperatures in those spaces.

Heating loads can be controlled by limiting the amount of heat that leaves a building, and/or optimising the amount of solar gain that enters a building.

Heating loads are regulated by Performance Requirement J1P2 and the associated compliance options outlined in Chapter 3. These compliance options include:

- NatHERS energy rating (Section 3.1)
- Elemental provisions (Section 3.2)
- VURB (Section 3.3)
- First principles (Section 3.5).

Reminder

The heating load, cooling load and total thermal energy load limits specified by J1P2 and associated compliance options, are not the same as the actual amount of energy used for heating and cooling.

The amount of energy used for heating and cooling depends on the source of the energy used (i.e. fuel type) and the efficiency of the heating and cooling equipment.

The amount of energy used for heating and cooling is regulated by J1P3.

⁵² YourHome, [Glossary](#) (2020), YourHome, accessed Oct 2022.

⁵³ [Green Building Council Australia](#).



Hours of operation: The number of hours when the occupancy of the building is greater than 20% of the peak occupancy.

House energy rating software: For the purposes of—Volume One, software accredited under the Nationwide House Energy Rating Scheme (NatHERS); or

(b) ...

Illumination power density: The total of the power that will be consumed by the lights in a space, including any lamps, ballasts, current regulators and control devices other than those that are plugged into socket outlets for intermittent use such as floor standing lamps, desk lamps or work station lamps, divided by the area of the space, and expressed in W/m².

The DTS Provisions for artificial lighting in J7D3 Volume One specify the lighting allowances permitted and these depend on the space the lights serve. The allowances can be increased by using an illumination power density adjustment factor. See section 3.1.2 and section 4.1.2 of this document for more information.

Indoor air quality: A measure of the condition of air in a room with respect to the health and comfort of its occupants. It includes the physical, chemical and microbiological makeup of the air. Note the term means different things to different people and there is no single accepted definition.

More information is available in the ABCB Indoor Air Quality Verification Methods Handbook (2023) that is available from the [ABCBC website](#).

Insulation: A material, assembly of materials, or building product which provides resistance to conductive or radiative heat flow. Examples include bulk insulation and reflective insulation.

Lamp power density: The total of the maximum power rating of the lamps in a space, other than those that are plugged into socket outlets for intermittent use such as floor standing lamps, desk lamps or work station lamps, divided by the area of the space, and expressed in W/m².

The DTS Provisions for artificial lighting in J7D3 (1) Volume One specify the lighting allowances permitted (i.e. lamp power density) and these depend on the space the lights serve. See section 3.1.2 and section 4.1.2 of this document for more information.



Main space conditioning: Either—

- (a) the heating or cooling equipment that serves at least 70% of the *conditioned space* of a dwelling, or
- (b) if no one heating or cooling equipment serves at least 70% of the *conditioned space* of the dwelling, the equipment that results in the highest net equivalent energy usage when calculated in accordance with J3D14(1)(a) of NCC Volume One or 13.6.2(1)(a) of the ABCB Housing Provisions.

(3) Notes

- (1) If a multi-split *air-conditioning* unit is installed, it is considered to be a single heating or cooling *service*.
- (2) A series of separate heaters or coolers of the one type can be considered a single heater or cooler type with a performance level of that of the unit with the lowest efficiency.

Mechanical ventilation: The use of outside air which has been distributed within the building, most commonly through the use of one or more fans⁵⁴. More information is available from [YourHome](#).

Mechanical ventilation system: A powered means of using fans to distribute outside air within a building for either heating, cooling or fresh air purposes. A typical mechanical ventilation system is usually comprised of an external air handling unit that is connected to internal ductwork that delivers and extracts air from the building.

Membrane: A barrier impervious to moisture.

NABERS Energy: The National Australian Built Environment Rating Systems for energy efficiency, which is managed by the NSW Government.

Nationwide House Energy Rating Scheme (NatHERS): A scheme administered by the Commonwealth on behalf of all states and territories that facilitates consistent energy ratings from NatHERS accredited tools for new⁵⁵ Australian homes.

More information is available from [NatHERS](#).

Net equivalent energy usage (annual allowance): The net equivalent energy usage, or allowance, is assessed by taking to account of the floor area, space conditioning, water heating,

⁵⁴ YourHome, [Ventilation and airtightness](#) (2020), YourHome, accessed 2022.

⁵⁵ 'New' includes proposed new homes and apartments and proposed 'new building work' to existing homes and apartments. What constitutes 'new building work' is determined by each jurisdiction.



swimming pool and spa pump energy use. It is determined in accordance with J3D14 Volume One.

The ABCB Whole-of-home calculator can be used to determine the net equivalent energy usage. See section 3.2.2.6 of this document for more information.

Objective: A statement providing guidance on the public's expectation of requirements in the NCC. The objective for apartment building energy efficiency is located in NCC Volume One J101. See Chapter 2 for more information.

Orientation: The position of a building based on climate, solar exposure and wind direction⁵⁶. More information is available from [YourHome](#).

Outdoor air: Air outside the building.

On-site energy production: Energy produced on-site through sources such as solar panels.

On-site energy production is accounted for in Performance Requirement J1P3 the associated DTS compliance options: NatHERS and Elemental (see Chapter 3). On-site energy production is also considered in Performance Requirements J1P1 and J1P4.

Passive cooling: Using the design of the building and selection of materials to manage the temperature during hot weather⁵⁷. More information is available from [YourHome](#).

Passive heating: Using the design of the building and selection of materials to utilise the sun to increase and trap that warmth⁵⁸. The glazing calculations allow for the heating of a home from solar gains through glazing. More information is available from [YourHome](#).

Performance Requirement: A requirement which states the level of performance which a *Performance Solution* or *Deemed-to-Satisfy Solution* must meet.

Performance Solution: A method of complying with the *Performance Requirements* other than by a *Deemed-to-Satisfy Solution*.

Piping: For the purposes of Section J in Volume One or Part H6 in Volume Two, and Section 13 of the Housing Provisions, means an assembly of pipes, with or without valves or other fittings, connected together for the conveyance of liquids and gases.

Pliable building membrane: A water barrier as classified by AS/NZS 4200.1.

Predicted Mean Vote (PMV): The Predicted Mean Vote of the thermal perception of building occupants determined in accordance with ANSI/AHSRAE Standard 55.

⁵⁶ YourHome, [Orientation](#) (2020), YourHome, accessed 2022.

⁵⁷ YourHome, [Passive cooling](#) (2020), YourHome, accessed 2022.

⁵⁸ YourHome, [Passive heating](#) (2020), YourHome, accessed 2022.



Primary insulation layer: The most interior insulation layer of a wall or roof construction.

Projection: The depth of a horizontal overhang as defined by NCC 2022 Figure S37C7. Provides shading which extends horizontally on both sides of the glazing, generally located externally. This could be in a form of a verandah, balcony, fixed canopy, eaves, shading hood or a carport⁵⁹. More information is available from [YourHome](#).

R-Value: The thermal resistance of a component calculated by dividing its thickness by its thermal conductivity, expressed in $m^2.K/W$.

For bulk insulation products, this is simply the R-Value shown on the packaging. For reflective products, the R-Value they add to a building component is more complicated. Reflective insulation only works when installed in conjunction with an air space. The R-Value that a reflective product adds to a component is the R-Value of the reflective air space(s), less the R-Value of any non-reflective air spaces that the reflective air space(s) replaces.

Reclaimed energy: NCC Volume One Clause J6D10 (d) allows reclaimed heat from another process such as from a refrigeration plant and bio-fuels to be used. This reclaimed energy can be used in conjunction with one or more heaters allowed under J6D10. Examples of reclaimed energy could be the waste heat captured to heat water from a refrigeration chiller (rather than being rejected to a cooling tower); or energy from a process unrelated to building services, such as steam condensate from a laundry process.

Reference building:

For the purposes of—Volume One, a hypothetical building that is used to calculate the maximum allowable—

- (i) *annual greenhouse gas emissions* for the common area of a Class 2 building or a Class 3 to 9 building; or
 - (ii) *heating load, cooling load and energy value* for a *sole-occupancy unit* of a Class 2 building or a Class 4 part of a building; or
- (b)

Reflective insulation: A building membrane with a reflective surface such as a reflective foil laminate, reflective barrier, foil batt or the like capable of reducing radiant heat flow.

Renewable energy: Energy that is not depleted when used. Renewable energy includes solar, wind and geothermal power⁶⁰.

⁵⁹ YourHome, [Shading](#) (2020), YourHome, accessed 2022.

⁶⁰ YourHome, [Renewable energy](#) (2020), YourHome, accessed 2022.



More information is available from [YourHome](#).

Required: Required to satisfy a *Performance Requirement* or a *Deemed-to-Satisfy Provision* of the NCC as appropriate.

Roof light: For the purposes of Section J and Part F6 in NCC Volume One, Part H6 in NCC Volume Two, and Part 10.5 and Section 13 of the ABCB Housing Provisions, a skylight, window or the like installed in a roof—

- (a) to permit natural light to enter the room below; and
- (b) at an angle between 0 and 70 degrees measured from the horizontal plane.

Roof light shaft index: is determined by measuring the distance from the centre of the shaft at the roof to the centre of the shaft at the ceiling level and dividing it by the average internal dimension of the shaft opening at the ceiling level. See Table J4D5 NCC Volume One, Note 1.

Sarking-type material: A material such as a *reflective insulation* or other flexible membrane of a type normally used for a purpose such as waterproofing, vapour management or thermal reflectance.

Service:

For the purposes of Section J in Volume One, means a mechanical or electrical system that uses energy to provide *air-conditioning*, mechanical ventilation, *heated water* supply, artificial lighting, vertical transport and the like within a building, but which does not include—

- (a) systems used solely for emergency purposes; and
- (b) cooking facilities; and
- (c) portable appliances.

Shading device: A device used to block direct rays from the sun, generally these devices are fixed or operable. Some examples of these are awnings, blinds and eaves⁶¹. More information is available from [YourHome](#).

Skylight: A type of window located on a roof to permit light to enter a room below. The NCC defines this as a roof light.

Solar absorptance: A measure of the solar radiation which an object can absorb. The higher the solar absorptance, the more heat it can absorb. Lighter coloured materials are commonly more reflective and absorb less heat. More information is available from [BASIX](#)⁶².

⁶¹ YourHome, [Shading](#) (2020), YourHome, accessed 2022.

⁶² BASIX, [Roof colour and solar absorptance](#), BASIX, accessed 2022.



Solar gain: Heat gained through solar radiation entering a building through windows or skylights.⁶³ More information on solar gain and how to use solar gain for passive heating can be found at [YourHome](#).

Specification: A specification provides technical data in the NCC which is relied upon as a component of one or more DTS Provisions. A specification may be referenced by multiple DTS Provisions, wherever the same data needs to be referred to by different parts of the NCC. Including this common information in a single specification avoids the need to repeat the same information across multiple parts of the NCC.

Storey: A space within a building which is situated between one floor level and the floor level next above, or if there is no floor above, the ceiling or roof above, but not—

- (a) a space that contains only—
 - (i) a lift *shaft*, stairway or meter room; or
 - (ii) a bathroom, shower room, laundry, water closet, or other *sanitary compartment*; or
 - (iii) accommodation intended for not more than 3 vehicles; or
 - (iv) a combination of the above; or
- (b) a *mezzanine*.

Swimming pool: Any excavation or structure containing water and principally used, or that is designed, manufactured or adapted to be principally used for swimming, wading, paddling, or the like, including a bathing or wading pool, or spa.

Thermal break: A material of low conductivity which is used between materials with high conductivity to reduce its heat transfer.

Thermal bridging: Thermal bridging, in practical terms for the NCC, is an unintended path of heat flow between the outside and inside of the building envelope. Thermal bridges may occur where there is an interruption in the insulation or where highly conductive materials (e.g. metal) are used.

As an example, if a steel truss roof directly supports an insulated corrugated iron roof, the heat flows through the truss more readily than the surrounding insulation, negating the effect of the insulation (i.e. the truss acts as a thermal bridge).

Thermal bridges can significantly reduce the effectiveness of the insulation (thermal resistance) of the building envelope (i.e. walls, floors and roof) by essentially bypassing the insulation in

⁶³ [YourHome](#), (2020), YourHome, accessed 2022.



favour of a more conductive material (e.g. metal). This results in either losing heat from inside the building to the outside on a cold day or adding warmth to the inside the building on a hot day.

This may cause unwanted comfort issues in a building, and a likely increase in energy use by a building's heating and cooling systems. Additionally, unaddressed thermal bridges may lead to condensation where warm, moist air contacts a colder surface and condenses into water droplets. Condensation can result in mould growth, causing indoor air quality issues, negative health impacts for occupants, and potentially affects the durability of the structure.

Thermal comfort level: The level of thermal comfort in a building expressed as a PMV sensation scale.

Thermal energy load: The sum of the *heating load* and the *cooling load*.

Thermal conductivity: Thermal conductivity is defined as the rate of thermal conduction through a material per unit area per unit thickness per unit temperature differential.

Reminder

The heating load, cooling load and total thermal energy load limits specified by J1P2 and associated compliance options, are not the same as the actual amount of energy used for heating and cooling.

The amount of energy used for heating and cooling depends on the source of the energy used (i.e. fuel type) and the efficiency of the heating and cooling equipment.

The amount of energy used for heating and cooling is regulated by J1P3.

Thermal performance: The effectiveness of a building envelope to maintain acceptable levels of human comfort inside a building relative to the outside weather conditions, while minimising the need for artificial heating or cooling⁶⁴.

More information is available from [YourHome](#).

Thermal rating: A thermal rating is a computer simulation using accredited NatHERS software that assesses the potential thermal performance of a new⁶⁵ home. The results are converted to a star rating between 1 and 10.

Total R-Value: The sum of the *R-Values* of the individual component layers in a composite element including any building material, insulating material, airspace, thermal bridging and associated surface resistances, expressed in m².K/W.

⁶⁴ YourHome, [Glossary](#) (2020), YourHome, accessed 2022.

⁶⁵ 'New' includes proposed new homes and apartments and proposed 'new building work' to existing homes and apartments. What constitutes 'new building work' is determined by each jurisdiction.



Total System Solar Heat Gain Coefficient: For the purposes of—Volume One, the fraction of incident irradiance on a *wall-glazing construction* or a *roof light* that adds heat to a building's space; or

(b) ...

Total System U-Value: The sum of the *R-Values* of the individual component layers in a composite element including any building material, insulating material, airspace, thermal bridging and associated surface resistances, expressed in $\text{m}^2.\text{K}/\text{W}$.

Unconditioned space: A space that is not usually heated or cooled by the building's domestic services. Examples include laundries and bathrooms.

Ventilation opening: An opening in the *external wall*, floor or roof of a building designed to allow air movement into or out of the building by natural means including a permanent opening, an openable part of a *window*, a door or other device which can be held open.

Vapour barrier: A layer or material used to restrict the transmission of vapour, generally water vapour into a building or from inside into the cavity of the building fabric⁶⁶.

More information is available in the ABCBC Condensation in Buildings Handbook (2023) which is available from the [ABCBC website](#).

Vapour permeance: The degree that water vapour is able to diffuse through a material, measured in $\mu\text{g}/\text{N.s}$ and tested in accordance with the ASTM-E96 Procedure B – Water Method at 23°C 50% relative humidity.

Verification Method: A test, inspection, calculation or other method that determines whether a *Performance Solution* complies with the relevant *Performance Requirements*.

Wall-glazing construction: For the purposes of Section J in Volume One, the combination of wall and glazing components comprising the *envelope* of a building, excluding—

(a) *display glazing*; and

(b) opaque non-glazed openings such as doors, vents, penetrations and shutters.

WOH energy use: The total amount of energy used by a home and includes:

The efficiency of fixed⁶⁷ energy-using equipment, such as heating and cooling equipment, heated water, lighting, and pool and spa pumps

On-site renewable energy generating systems, such as rooftop solar PV.

⁶⁶ ABCBC (2023) Condensation in buildings handbook, accessed Oct 2023.

⁶⁷ Portable appliances and equipment are excluded.



WOH rating: A WOH rating is a computer simulation using NatHERS accredited software that assesses equipment efficiencies and any offsets from on-site renewable energy of a proposed house. A WOH rating builds on the thermal performance assessment (i.e. star rating) of a proposed SOU. The results are converted to a score between 1 and 100.



Appendix C Compliance with the NCC

C.1 Responsibilities for regulation of building and plumbing in Australia

State and territory governments are responsible for regulation of building, plumbing and development/planning in their respective state or territory.

The NCC is a joint initiative of the Commonwealth and State and Territory Governments in Australia and is produced and maintained by the ABCB on behalf of the Australian Government and each state and territory government. The NCC provides a uniform set of technical provisions for the design and construction of buildings and other structures, and plumbing and drainage systems throughout Australia. It allows for variations in climate and geological or geographic conditions.

The NCC is given legal effect by building and plumbing regulatory legislation in each state and territory. This legislation consists of an Act of Parliament and subordinate legislation (e.g. Building Regulations) which empowers the regulation of certain aspects of buildings and structures, and contains the administrative provisions necessary to give effect to the legislation.

Each state's and territory's legislation adopts the NCC subject to the variation or deletion of some of its provisions, or the addition of extra provisions. These variations, deletions and additions are generally signposted within the relevant section of the NCC, and located within appendices to the NCC. Notwithstanding this, any provision of the NCC may be overridden by, or subject to, state or territory legislation. The NCC must therefore be read in conjunction with that legislation.

C.2 Demonstrating compliance with the NCC

Compliance with the NCC is achieved by complying with the NCC Governing Requirements and relevant Performance Requirements.

The Governing Requirements are a set of governing rules outlining how the NCC must be used and the process that must be followed.

The Performance Requirements prescribe the minimum necessary requirements for buildings, building elements, and plumbing and drainage systems. They must be met to demonstrate compliance with the NCC.

There are 3 options available to demonstrate compliance with the Performance Requirements. These are:

- a Performance Solution
- a Deemed-to-Satisfy Solution, or



- a combination of a Performance Solution and a Deemed-to-Satisfy Solution.

Wherever a Performance Solution is used, it must be assessed using one or a combination of Assessment Methods, as appropriate. These include:

- Evidence of Suitability
- Expert Judgement
- Verification Methods
- Comparison with DTS Provisions.

Evidence of suitability and Expert Judgement may be used to demonstrate compliance for a DTS Solution.

A figure showing hierarchy of the NCC and its compliance options is provided in Figure C.1. It should be read in conjunction with the NCC.

To access the NCC or for further general information regarding demonstrating compliance with the NCC visit the [ABCBC website](http://www.abcb.gov.au).

Figure C.1 Demonstrating compliance with the NCC





Appendix D Examples for an SOU

This appendix contains 7 examples to assist with understanding and applying the energy efficiency DTS Provisions and Verifications Methods in the NCC relevant to an SOU in a Class 2 apartment building.

The examples and their location in this appendix are listed and hyperlinked in Table D.1 Examples and their location

They should be read in conjunction with a copy of NCC Volume One.

Table D.1 Examples and their location

Appendix Examples	Page reference
D.1 Heating and cooling load limits	203- 204
D.2 Building fabric	205 - 209
D.3 Glazing	210 - 215
D.4 Ceiling fans	216 - 217
D.5 WOH energy usage	218 - 222
D.6 Artificial lighting	223 - 225
D.7 Verification of building envelope sealing	226 - 228



D.1 Heating and cooling load limits

D.1.1 Example 1: An SOU of an apartment building in Brisbane

Introduction

A DTS Solution using the DTS Provisions of the NatHERS compliance option is proposed for an SOU of an apartment building in Brisbane.

This example provides guidance on the heating and cooling load limit requirements that are part of the NatHERS compliance option. See Chapter 3 for more information on this compliance option.

The relevant NCC references are Volume One J1P2, J3D3, Specification 44 and the ABCB Standard for NatHERS Heating and Cooling Load Limits (2022).

Step 1: Identify the requirements that need to be met

To comply with J3D3(1)(a), the modelled energy loads of an SOU must not exceed 3 separate load limits:

- The total load limit corresponding to the required thermal rating.
- The heating load limit.
- The cooling load limit.

The modelled energy loads and the 3 load limits are determined in the following steps.

Step 2: Identify the required thermal rating

The city of Brisbane is in NCC climate zone 2 (NatHERS climate zone 10).

The required thermal ratings for the SOUs of an apartment building are:

- Collectively achieve an average energy rating of not less than 7 stars, and
- Individually achieve an energy rating of not less than 6 stars

For an individual SOU like the one in this example, this means the proposed SOU design needs to achieve a thermal rating greater than or equal to 6.0 stars.

Step 3: Identify heating and cooling load limits

J3D3(1)(a) also requires the SOU to not exceed the heating load limits and cooling load limits stated in the Standard.

Clause 2.3(4) of the Standard sets the heating and cooling loads limits for an SOU of a Class 2 or Class 4 part of a building.



Referring to Table 7 in the Standard for an SOU of an apartment building and a thermal rating of 6.0 stars in NatHERS climate zone 10, it shows the SOU design must not exceed a heating load limit of 25 MJ/m².annum and a cooling load limit of 45 MJ/m².annum.

The heating and cooling load limits are summarised in Table D.2.

Table D.2 Heating and cooling load limits

NatHERS climate zone	Heating load limit (MJ/m ² .annum)	Cooling load limit (MJ/m ² .annum)
10	25	45

Step 4: Calculate the 3 loads of the proposed unit

The SOU design is modelled using software accredited under NatHERS, as required by J3D3(a). The design achieves a 6.1 star rating. The software also shows that the heating load for the SOU design is 22.0 MJ/m².annum while the cooling load is 40.2 MJ/m².annum.

This information can be sourced from the NatHERS Universal Certificate for the proposed SOU. An example of a NatHERS Universal Certificate that includes where the heating and cooling loads are listed in the certificate is available from the [NatHERS website](#). The load limits for the total load, heating load and cooling load for NatHERS climate zone 10 along with the calculated loads of the proposed house design, are summarised in Table D.3.

Table D.3 Heating and cooling load limits

Scenario and outcome	Thermal rating (stars)	Heating load limit (MJ/m ² .annum)	Cooling load limit (MJ/m ² .annum)
Load limits for NatHERS climate zone 10	6	25	45
Calculated loads of proposed house	6.1	22.0	40.2
J3D3(1)(a) met?	Yes	Yes	Yes

Outcome

The individual heating, cooling and total loads do not exceed the respective load limits defined for NatHERS climate zone 10. This means the SOU's design complies with J3D3(1)(a) and J3D3(2). Note the other requirements listed in J3D3(1)(b)-(f) must also be complied with.



D.2 Building fabric

D.2.1 Example 2: An SOU on the top storey of a three-storey Class 2 building in Melbourne

Introduction

A DTS Solution using the DTS Provisions that form the Elemental compliance option is proposed for an SOU of an apartment building in Melbourne. See Chapter 3 for more information on this compliance option.

The calculations provided are limited to those required for the building fabric i.e. Part J3 Elemental provisions for an SOU of an apartment building or a Class 4 part of a building and Part J4 Building fabric.

The site and construction details are summarised in Table D.4.

Table D.4 Site and construction details

SOU detail	Description
Building location	Melbourne
NCC climate zone	6
NCC building classification	An SOU of an apartment building
Roof & ceiling general arrangements	<ul style="list-style-type: none"> Flat with flat ceiling directly fixed to metal battens Eaves as shown on plans – roof of balcony area considered as eave Metal sheet roof – colour – Colourbond ‘Monument’ – Solar Absorptance (SA) 0.73 roof with tile SA = 0.579 Downlights to 0.5% of plan area of ceiling
External wall general arrangements	<ul style="list-style-type: none"> Steel framed, bulk insulation with weather barrier Lightweight external fibre cement cladding – Colourbond ‘Shale Grey’ – SA = 0.43 Wall height = 2400 mm
Windows(door) and walls	<ul style="list-style-type: none"> North glazing = 11.52 m², East glazing = 11.07 m² North wall area = 29.6 m², East wall area = 22.8 m²
Floors	<ul style="list-style-type: none"> Concrete floor



- Floor area of building Class 2 SOU – approx. 107m²

**Step 1: Application requirements (clause J2D2(2)(b))**

Since this example is for an SOU of an apartment building, clause J2D2(2)(b) applies.

Step 2: Roof thermal break requirements (J3D5)

Clause J3D5 requires a roof thermal break of R0.2 as all components of the roof are metal with the ceiling lining being directly fixed to the components.

As the building is of Type A construction for fire safety purposes, this component is to be a non-combustible strip applied over the vapour permeable membrane and framing members.

Step 3: Wall thermal break requirements (J3D6)

Clause J3D6 requires a wall thermal break of R0.2 as the wall lining of the example building is directly fixed to the metal frame and the external cladding is a fibre-cement product.

As the building is of Type A construction this component is to be non-combustible strip, as stated in C2D10, applied over the vapour permeable membrane and framing members.

Step 4: Roof and ceiling requirements (J3D7)

Clause J3D7 Roofs requires the following:

- J3D7(1)(f)(ii) requires the minimum R-Value to be achieved by a building in climate zone 6 is R3.5 or, if the roof contains reflective insulation, R3.0.
- There are no conditions applied to the SA of the upper surface of a roof in climate zone 6.
- For this example, it is assumed that reflective insulation has been installed in compliance with sub-clause J3D7(3)(b)(i) or (ii) making the nominated R-Value R3.0 (reflective insulation).
- Figure D.1 shows the thermal bridging in a metal-framed roof is addressed through the Total R-Value of roof, as shown in Table J3D7t.

Figure D.1 Minimum Total R-Value to account for thermal bridging



Table J3D7t: Metal-framed flat, skillion or cathedral roof — minimum Total R-Value to account for thermal bridging

Ceiling insulation R-Value from Tables J3D7a to J3D7r, and J3D7(1)(f) as applicable	Minimum Total R-Value to account for thermal bridging: heat flow down	Minimum Total R-Value to account for thermal bridging: heat flow up
1.0	1.40	1.32
1.5	1.86	1.78
2.0	2.29	2.21
2.5	2.71	2.63
3.0	3.11	3.02
3.5	3.31	3.22
4.0	3.66	3.57
4.5	3.98	3.90
5.0	4.32	4.22
5.5	4.63	4.53
6.0	4.93	4.82

Due to operational or safety reasons, the loss of insulation must be compensated for in accordance with Table J3D7w, as shown in the following Figure D.2.

Figure D.2 Adjusted minimum R-Value of ceiling insulation required to compensate for loss of ceiling insulation area

Table J3D7w: Adjusted minimum R-Value of ceiling insulation required to compensate for loss of ceiling insulation area

Percentage of ceiling area uninsulated	Minimum R-Value of ceiling insulation required to satisfy J3D7(1) and J3D7(3)									
	1.0	1.5	2.0	2.5	3.0	3.5	4.0	4.5	5.0	5.5
0.5% to less than 1.0%	1.0	1.6	2.2	2.8	3.4	4.0	4.7	5.4	6.2	6.9
1.0% to less than 1.5%	1.1	1.7	2.3	2.9	3.6	4.4	5.2	6.1	7.0	X
1.5% to less than 2.0%	1.1	1.7	2.4	3.1	3.9	4.8	5.8	6.8	X	X
2.0% to less than 2.5%	1.1	1.8	2.5	3.3	4.2	5.3	6.5	X	X	X
2.5% to less than 3.0%	1.2	1.9	2.6	3.6	4.6	5.9	X	X	X	X
3.0% to less than 4.0%	1.2	2.0	3.0	4.2	5.7	X	X	X	X	X
4.0% to less than 5.0%	1.3	2.2	3.4	5.0	X	X	X	X	X	X

**Step 5: External wall requirements (J3D8)**

For J3D8(1)(a)(ii), the ratio of opaque external walls to the floor area is 28% (refer calculations below) which is $\geq 20\%$ and $< 35\%$, so the Total R-Value of the external walls must be a minimum of R2.04.

Glazing Area: $4(3.24) + 2.16 + 5.67 + 1.80 = 22.59$

Opaque External Wall Area: $[(12.34 \times 2.40) + (9.50 \times 2.4)] - 22.59 = 29.85$

Opaque External Wall Area to Floor Ratio: $29.85/107.0 \times 100 = 27.89\% \approx 28\%$

The 'Total System R-Value Calculator which is part of the ABCBC Façade Calculator tool was used to calculate the external wall Total R-Value for this example. A wall system using a steel frame, plasterboard, bulk insulation, a weather barrier, and external cladding was used. The insulation of this system was R2.0. When installed at 600 mm centres with a thermal break strip of R0.2, the overall R-Value of the system is R1.85.

Therefore the external wall complies with J3D8(1)(a)(ii).

J3D8(3) points to Table J3D8a, there is no requirement in climate zone 6 for external walls to achieve a minimum or maximum solar absorptance.

Figure D.3 Solar absorptance

Table J3D8a: Solar absorptance – climate zones 1 to 6

Climate zone	Opaque external wall to net floor area ratio	Permitted solar absorptance
1 and 3	$< 45\%$	≤ 0.8
	$\geq 45\%$	≤ 0.35
2	$< 35\%$	Any
	$\geq 35\%$	Any, or ≤ 0.35 , if shading device overhang is < 300 mm
4 and 5	$< 45\%$	Any
	$\geq 45\%$	≤ 0.35 , if shading device overhang is < 1500 mm
6	Any	Any

Step 6: Wall-glazing requirements (J3D9)

Compliance via the whole-of-façade pathway is not applicable as the minimum requirements for walls (clause J3D8) and windows (clauses J3D11-13) are being met separately.

Step 7: Floor requirements (J3D10)

There is no requirement for the floor of the building to have insulation installed under this clause as the floor is above the ground and not above a carpark.



Step 8: Summary of building fabric requirements

The following table shows a summary of the minimum requirements for the building fabric for Example 2, as determined from Steps 2 to 6 above.

Table D.5 Summary of building fabric requirements for Example 2

Building element	Minimum requirements
Roof	Total R-Value 3.11 (reflective insulation)
Walls	Total R-Value 2.04
Floors and subfloor walls	No requirement
Thermal Construction	In accordance with NCC Volume One J4
Floor Edge Insulation	No requirement



D.3 Glazing

D.3.1 Example 3: An SOU on the top storey of a three-storey Class 2 building in Melbourne

Introduction

A DTS Solution using the DTS Provisions that form the Elemental compliance option is proposed for an SOU of an apartment building in Melbourne. See Chapter 3 for more information on this compliance option.

The calculations provided are limited to those required for the external glazing. The relevant NCC references are Volume One J3D11, J3D12 and J3D13.

The site and construction details are summarised in Table D. 6.

Table D. 6 Site and construction details

Apartment detail	Description
Location	Melbourne
NCC climate zone	6
NCC building classification	An SOU of an apartment building
Floors	Concrete floor Floor area the SOU – approx. 107 m ²
Windows(door) and walls	Aluminium framed, double glazed – clear glass Black powder coated – SA = 0.96 North glazing = 11.52 m ² , East glazing = 11.07 m ² North wall area = 29.6 m ² , East wall area = 22.8 m ²

Window products and their thermal performance (Total System U-Value and Total System SHGC) were determined using window energy rating scheme, [WERS](#)

Windows: Total System U-Value = 4.2, Total System SHGC = 0.69

Door: Total System U-Value = 4.00, Total System SHGC = 0.68

**Step 1: Find the maximum winter glazing allowance**

In accordance with clause J3D11, the allowable ratio of glazing conduction (C_u) and solar heat gain (C_{SHGC}) of the glazing in the storey is given in Table J3D11a.

Figure D.4 shows that for an SOU in climate zone 6, the maximum $C_u/C_{SHGC} = 6.27$.

Figure D.4 Maximum conductance to solar heat gain ratio (Table J3D11a of NCC Volume One)

Table J3D11a: Maximum conductance to solar heat gain ratio (C_u/C_{SHGC})

Climate zone	Maximum conductance to solar heat gain ratio (C_u/C_{SHGC})
2	16.95
3	19.88
4	13.34
5	11.83
6	6.27
7	12.90

Step 2 Calculate design C_u/C_{SHGC} values

The design value of the ratio (C_u/C_{SHGC}) of glazing conduction (C_u) and solar gain (C_{SHGC}) is calculated in accordance with clause J3D11(1). An excerpt of the calculation is shown in the following figure.

Figure D. 5 Excerpt of external winter glazing calculation formula (J3D11)

$$\frac{[(A_1 \times U_1 \times BC_1 \times OC_1 \times R_{W1}) + (A_2 \times U_2 \times BC_2 \times OC_2 \times R_{W2}) + \dots]}{[(A_1 \times SHGC_1 \times E_{W1} \times R_{W1} \times BS_{W1} \times L_{W1} \times F_{W1} \times H_{W1}) + (A_2 \times SHGC_2 \times E_{W2} \times R_{W2} \times BS_{W2} \times L_{W2} \times F_{W2} \times H_{W2}) + \dots]}$$

Refer to J3D11(2) for a description of the required inputs for this calculation.

All the relevant values for this example have been entered into the ABCB Glazing Calculator to assist in this calculation, this is shown in Figure D.6 below.



Figure D. 6 Table of window design inputs in the ABCB Glazing calculator

Glazing element	Glazing elements, orientation sector, size and performance characteristics					Shading		Calculation data							
	Orientation	Size		Factors affecting impact of glazing performance		P&H or Device	Exposure	Size							
Description (optional)	Facing sector	Height (m)	Width (m)	Area (m ²)	Room type Bedroom / utility / other?	Adjacent Floor Covering	Frame Colour	Openability	Total System U-Value (AFRC)	Total System SHGC (AFRC)	P	H (m)	P/H	E _s	Area used (m ²)
1	N	1.80		3.24	Bedroom	Carpet	Dark	Awning	4.20	0.69	0.01	2.10	0.00	2.37	3.24
2	N	1.80		3.24	Other	Floating Timber	Dark	Awning	4.20	0.69	0.01	2.10	0.00	2.73	3.24
3	E	1.80		2.16	Other	Floating Timber	Dark	Awning	4.20	0.69	5.10	2.10	2.43	0.76	2.16
4	N	1.80		3.24	Other	Floating Timber	Dark	Awning	4.20	0.69	3.00	2.10	1.43	0.59	3.24
5	E	2.10		5.67	Other	Floating Timber	Dark	Sliding Door	4.00	0.68	2.40	2.40	1.00	1.33	5.67
6	N	1.80		1.80	Bedroom	Carpet	Dark	Awning	4.20	0.69	7.31	2.10	3.48	0.40	1.80
7	E	1.80		3.24	Bedroom	Carpet	Dark	Awning	4.20	0.69	0.10	2.10	0.05	2.92	3.24



Step 3 Check compliance

The ABCB Glazing calculator shows the design Cu/CSHGC accounts for 76.0%, of the allowance of 6.27 (determined in step 1) and therefore complies. Refer to Step 6 for the results from the ABCB Glazing Calculator.

Step 4 Determine summer glazing solar heat gain allowance

In accordance clause J3D12, the allowable aggregate solar heat gain of the glazing must not exceed the multiplication of the floor area by the constant CSHGC.

The floor area of storey x CSHGC = 107 x 0.4466 = 47.79, noting CSHGC = 0.4466 (ventilation opening of 21%) in climate zone 6. This is shown in the figure below.

Figure D. 7 Constant for solar heat gain coefficient (CSHGC): climate zones 1 to 7 (Table J3D12a)

% Ventilation opening area per m ²	Climate zone 1	Climate zone 2	Climate zone 3	Climate zone 4	Climate zone 5	Climate zone 6	Climate zone 7
5% to <10%	0.0191	0.0245	0.0547	0.0506	0.0674	0.1472	0.0930
10% to <15%	0.0237	0.0532	0.0745	0.0946	0.1111	0.2969	0.2405
15% to <20%	0.0294	0.0700	0.0861	0.1203	0.1367	0.3845	0.3267
20% to 90%	0.0364	0.0819	0.0943	0.1385	0.1548	0.4466	0.3879

Step 5 Determine design aggregate solar heat gain

The design value of aggregate solar heat gain of the glazing is calculated in accordance with the calculation at J3D12 (1)(b). An excerpt of this calculation is shown in the following Figure D.8.

Figure D.8 Excerpt of external glazing (summer) calculation (13.3.3 (1)(b) of Housing Provisions)

$$(A_1 \times SHGC_1 \times E_{S1} \times R_{S1} \times L_{S1} \times F_{S1} \times H_{S1}) + (A_2 \times SHGC_2 \times E_{S2} \times R_{S2} \times L_{S2} \times F_{S2} \times H_{S2}) + \dots$$

All the relevant values for this example have been entered into the ABCB NCC Volume One Glazing Calculator to assist in this example.

Step 6: Check summer compliance

The ABCB Glazing calculator outputs show the glazing design complies with the summer glazing allowance. The glazing design solar heat gain uses 73.6% of the allowed solar heat gain, see the two figures below.



Figure D. 9 ABCB Glazing calculator outputs

Shading		Calculation data			Winter outcomes		Summer outcomes	
P&H or Device		Exposure		Size	Conduction / Solar gain - PASSED 76.0%		Solar heat gain - PASSED 73.6%	
P (m)	H (m)	P/H	E _s	Area used (m ²)	% of winter heat loss	% of winter heat gain	SHGC x E _s x Area	Element share % of allowance used
0.01	2.10	0.00	2.37	3.24	13%	22%	5.3	20% of 74%
0.01	2.10	0.00	2.73	3.24	18%	39%	6.1	23% of 74%
5.10	2.10	2.43	0.76	2.16	10%	3%	1.1	4% of 74%
3.00	2.10	1.43	0.59	3.24	18%	11%	1.3	5% of 74%
2.40	2.40	1.00	1.33	5.67	24%	14%	5.1	20% of 74%
7.31	2.10	3.48	0.40	1.80	7%	2%	0.5	2% of 74%
0.10	2.10	0.05	2.92	3.24	10%	10%	6.5	25% of 74%

ian Building Codes Board website (abcb.gov.au). The Australian Building Codes Board, the
 on this publication, to the maximum extent permitted by law. No representation or warranty is made or
 anties are excluded to the extent permitted by law. This calculator is not legal or professional

If inputs are valid





ABCB

Apartment energy efficiency handbook

Figure D. 10 Screenshot of ABCB Glazing calculator

Glazing

1. Enter building name and description below - Identifying the particular part(s) covered by this assessment.
AEEH_Class2Glazing_Check2

Area of dwelling **107m²**
 Area of glazing **22.6m²** (21% of floor area)
 Number of rows for table below **7** (as currently displayed)

Climate zone **6**

Constants C_{g1} **6.27** C_{g2} **0.3297**

Allowances C_{g1} / C_{g2} **8.3** $C_{g1} \times Area$ **35.3**

ID	Glazing element Description (optional)	Orientation	Size			Factors affecting impact of glazing performance				Performance			Shading			Calculation data			Winter outcomes		Summer outcomes			
			Facing sector	Height (m)	Width (m)	Area (m ²)	Room type	Adjacent Floor Covering	Frame Colour	Openability	Total System U-Value (AFRC)	Total System SHGC (AFRC)	P&H or Device	P (m)	H (m)	Exposure	E _s	Area used (m ²)	% of winter heat loss	% of winter heat gain	Conduction / Solar gain - PASSED	Solar heat gain - PASSED	Element share % of allowance used	
1		N	1.80	3.24	Bedroom	Carpet	Dark	Awning	4.20	0.69	0.01	2.10	0.00	2.37	3.24	13%	22%	5.3	20%	74%	73%	5.3	20%	74%
2		N	1.80	3.24	Other	Floating Timber	Dark	Awning	4.20	0.69	0.01	2.10	0.00	2.73	3.24	18%	39%	6.1	23%	74%	73%	6.1	23%	74%
3		E	1.80	2.16	Other	Floating Timber	Dark	Awning	4.20	0.69	5.10	2.10	2.43	0.76	2.16	10%	3%	1.1	4%	74%	73%	1.1	4%	74%
4		N	1.80	3.24	Other	Floating Timber	Dark	Awning	4.20	0.69	3.00	2.10	1.43	0.59	3.24	18%	11%	1.3	5%	74%	73%	1.3	5%	74%
5		E	2.10	5.67	Other	Floating Timber	Dark	Sliding Door	4.00	0.68	2.40	2.40	1.00	1.33	5.67	24%	14%	5.1	20%	74%	73%	5.1	20%	74%
6		N	1.80	1.80	Bedroom	Carpet	Dark	Awning	4.20	0.69	7.31	2.10	3.48	0.40	1.80	7%	2%	0.5	2%	74%	73%	0.5	2%	74%
7		E	1.80	3.24	Bedroom	Carpet	Dark	Awning	4.20	0.69	0.10	2.10	0.05	2.92	3.24	10%	10%	6.5	25%	74%	73%	6.5	25%	74%

IMPORTANT NOTICE AND DISCLAIMER IN RESPECT OF THE GLAZING CALCULATOR

By accessing or using this calculator, you agree to the following. While care has been taken in the preparation of this calculator, it may not be complete or up-to-date. You can ensure that you are using a complete and up-to-date version by checking the Australian Building Codes Board website (abc.gov.au). The Australian Building Codes Board, the ABCB, and the ABCB staff do not accept any liability for any loss or damage, including consequential, special, or exemplary damages, or for any loss or damage of any kind, whether in contract, tort, or otherwise, arising from the use of this calculator. Persons using this calculator do so at their own risk and must take responsibility for assessing the relevance and accuracy of the information in relation to their particular circumstances. For information regarding this publication, see abc.gov.au.

© Commonwealth of Australia and the States and Territories of Australia 2023, published by the Australian Building Codes Board. The material in this publication is licensed under a Creative Commons Attribution-4.0 International license, with the exception of third party materials and any trade marks. It is provided for general information only and without warranties of any kind. More information on this CC BY license is set out at the Creative Commons website (creativecommons.org). For information regarding this publication, see abc.gov.au.



D.4 Ceiling fans

D.4.1 Example 4: An SOU of a Class 2 building in Toowoomba

Introduction

A DTS Solution using the DTS Provisions that form the Elemental compliance option is proposed for an SOU of a Class 2 building in Toowoomba. See Chapter 3 for more information on this compliance option.

The calculations provided are limited to those required for ceiling fans as specified in Clause J3D4 NCC 2022 Volume One.

Step 1: Determine climate zone and room sizes

The Class 2 building is a two-story brick building in climate zone 5 in Queensland. The SOU is on the ground floor.

Within this SOU, the room sizes are, where the fans are to be installed:

- dining/family room = 42 m²
- entertainment room = 24 m²

Step 2: Air movement using ceiling fans

Clause J3D4 states that ceiling fans must be installed in accordance with Table J3D4.

An excerpt of Table J3D4 is shown in Figure D.11. It shows that a minimum number of ceiling fans are required in habitable rooms (other than bedrooms) in NCC climate zone 5.

Figure D.11 Minimum ceiling fan requirements in climate zones 1, 2, 3 and 5 (Table J3D4 of Volume One)

Size of room (m ²)	Minimum number and diameter (mm) of ceiling fans required for a bedroom in climate zones 1, 2 and 3	Minimum number and diameter (mm) of ceiling fans required in a habitable room other than a bedroom in climate zones 1, 2, 3 and 5 (NSW and Qld)
< 15	1 x 900	1 x 900
≥ 15 to < 20	1 x 1200	1 x 1200
≥ 20 to < 25	1 x 1200	1 x 1400
≥ 25 to < 30	1 x 1400	2 x 1200
≥ 30 to < 45	1 x 1400	2 x 1400
≥ 45 to < 50	2 x 1400	3 x 1200
≥ 50	2 x 1400	3 x 1400

The ceiling fan requirements are summarised in Table D.7.



Table D.7 Summary of required ceiling fans

Room	Required ceiling fan(s)
Family/dining room	2 x 1400 mm
Entertainment room	1 x 1400 mm



D.5 WOH energy usage

D.5.1 Example 5: An SOU of Class 2 building in Canberra with 3 kW rooftop solar PV

Introduction

A DTS Solution using the DTS Provisions that form the Elemental compliance option is proposed for a SOU of an apartment building in Canberra. See Chapter 3 for more information on this compliance option.

The calculations provided are limited to those required for WOH energy usage i.e. Clause J3D14 Net equivalent energy usage of a SOU unit of an apartment building or a Class 4 part of a building.

The building is in NCC climate zone 7 and the SOU has a floor area of 139 m²

The SOU will have the following domestic services:

- Heater: single split ducted system - 2019 GEMS Determination is 2 stars
- Cooling: single split ducted system - 2019 GEMS Determination is 2.5 stars
- Water heater: heat pump heated water system
- Spa: No
- Pool: No
- Solar: Solar system to be installed – 3 kW is apportioned to the SOU

Note: As outlined above, this example uses a ducted split system rated under the 2019 Determination. This means the star ratings are based on the 'cold' zone of the air conditioner zoned energy rating label (ZERL). The star ratings will likely be different for the 'average' and 'hot' zones.

Step 1: Determine net equivalent energy allowance (annual energy allowance)

From Clause J3D14(1)(b), the energy allowance = $A \times E_F$.

A = the floor area factor obtained by multiplying the total floor area by the adjustment factor in Table J3D14a and E_F the energy factor obtained from Table J3D14b.

Figure D.12 shows an excerpt of Table J3D14a shows the floor adjustment factor = 0.0101.

Figure D.12 Floor area adjustment factor for SOU of an apartment building or a Class 4 part of a building (Table J3D14a, NCC 2022 Volume One)



Total floor area m ²	Floor area factor	Total floor area m ²	Floor area factor	Total floor area m ²	Floor area factor	Total floor area m ²	Floor area factor
<50	0.0123	160–169	0.0097	280–289	0.0087	400–409	0.0080
50–59	0.0119	170–179	0.0096	290–299	0.0086	410–419	0.0079
60–69	0.0116	180–189	0.0095	300–309	0.0085	420–429	0.0079
70–79	0.0113	190–199	0.0094	310–319	0.0085	430–439	0.0078
80–89	0.0111	200–209	0.0093	320–329	0.0084	440–449	0.0078
90–99	0.0108	210–219	0.0092	330–339	0.0083	450–459	0.0077
100–109	0.0106	220–229	0.0091	340–349	0.0083	460–469	0.0077
110–119	0.0105	230–239	0.0090	350–359	0.0082	470–479	0.0077
120–129	0.0103	240–249	0.0090	360–369	0.0082	480–489	0.0076
130–139	0.0101	250–259	0.0089	370–379	0.0081	490–499	0.0076
140–149	0.0100	260–269	0.0088	380–389	0.0081	500	0.0075
150–159	0.0099	270–279	0.0087	390–399	0.0080	—	—

Figure D. 13 shows an excerpt of Table J3D14b shows that E_F = 3.66.

Figure D. 13 Energy factor (EF) (Table J3D14b, NCC 2022 Volume One)

Climate zone	ACT	NSW	NT	QLD	SA	TAS	Vic	WA
1	—	—	2.73	3.95	—	—	—	4.64
2	—	1.88	—	2.54	—	—	—	—
3	—	—	1.76	3.52	—	—	—	4.10
4	—	2.57	—	—	2.65	—	1.79	3.34
5	—	2.50	—	3.26	2.56	—	—	3.36
6	—	3.43	—	—	3.58	—	2.32	4.58
7	3.66	3.32	—	—	—	4.41	2.32	—
8	—	5.70	—	—	—	5.60	4.02	—

This means the energy allowance = A X E_F = 139 X 0.0101 X 3.66 = 5.1kW

Step 2: Determine net equivalent energy usage (annual energy use)

From J3D14(1)(a) the net equivalent energy usage = (A X E_E) +E_P+E_S-E_R

A = floor area multiplied by floor area adjustment factor obtained from Table J3D14a.

From Step 1, A = 139×0.0101=1.404.

E_E is obtained from the ABCB Standard for Whole-of-Home Efficiency Factors (2022) for the main space conditioning, and main water heater.

The heating and cooling system is a single split system ducted system with a 2- and 2.5-star rating respectively using GEMS.

The water heater is a heat pump heated water system.

The relevant table in the ABCB Standard for Whole-of-Home Efficiency Factors (2022) is Table 7.2.4 and an excerpt is shown in Figure D.14 with the services for this example selected.

Therefore E_E = 2.347.



Figure D.14 Whole-of-home efficiency factors EE (kW/100 m²) – climate zone 7 – heat pump heating – Australian Capital Territory (Table 7.2.4 of the ABCBC Standard for Whole-of-Home Efficiency Factors)

Main type of heater	Main type of cooler	Electric storage (standard)	Electric storage (off peak)	Heat pump (standard)	Heat pump (off-peak)	Solar electric (standard)	Gas storage	Gas instantaneous	Solar gas
Heat pump - Ducted < 2.25 Stars (< 3)	Heat pump - Non-ducted < 3.75 stars (< 6)	4.128	3.403	2.307	2.097	2.200	4.529	3.907	1.862
Heat pump - Ducted < 2.25 Stars (< 3)	Heat pump - Non-ducted ≥ 3.75 stars (≥ 6)	4.075	3.351	2.254	2.044	2.147	4.477	3.855	1.810
Heat pump - Ducted < 2.25 Stars (< 3)	Other or none specified	4.284	3.562	2.468	2.259	2.362	4.686	4.066	2.025
Heat pump - Ducted < 3.0 Stars (< 4.5)	Evaporative	3.829	3.099	1.992	1.785	1.893	4.224	3.601	1.540
Heat pump - Ducted < 3.0 Stars (< 4.5)	Heat pump - Ducted < 2.25 stars (< 3)	4.163	3.441	2.347	2.138	2.241	4.565	3.945	1.904
Heat pump - Ducted < 3.0 Stars (< 4.5)	Heat pump - Ducted < 3 stars (< 4.5)	4.120	3.398	2.304	2.096	2.198	4.522	3.902	1.861
Heat pump - Ducted < 3.0 Stars (< 4.5)	Heat pump - Ducted < 3.75 stars (< 6)	4.056	3.334	2.240	2.031	2.134	4.458	3.838	1.797
Heat pump - Ducted < 3.0 Stars (< 4.5)	Heat pump - Ducted ≥ 3.75 stars (≥ 6)	3.992	3.270	2.176	1.967	2.070	4.394	3.774	1.733

$E_P = 0$ (no pool)

$E_S = 0$ (no spa)

The net equivalent energy usage:

$$= (A \times E_E) + E_P + E_S - E_R$$

$$= (139 \times 0.0101 \times 2.347) + 0 + 0 - 3 \text{ (kW of rooftop solar PV apportioned to the SOU as planned)}$$

$$= 3.3 - 3 = 0.3 \text{ kW}$$

**Step 3: Compare with the energy allowance E_F calculated in Step 1**

The net equivalent energy usage = 0.3 kW from Step 2 is less than $A \times E_F = 5.1$ kW from Step 1 and therefore complies.

In this example the WOH requirements can be satisfied even without rooftop solar PV apportioned to the SOU. Without rooftop solar PV off-set, the net equivalent energy usage is 3.3 kW, which is still smaller than the allowance $A \times E_F = 5.1$ kW.

Step 4: Check using the ABCB WOH Whole-of-home calculator

Figure D. 15 shows the above input values in the ABCB Whole-of-home calculator with the same outcome achieved.

Step 5 Results

The WOH energy requirements are met as the:

- Net equivalent energy allowance is 5.1 kW
- Net equivalent energy usage is 0.3 kW.



Figure D. 15 Whole-of-home calculator screenshot – Canberra



Whole-of-home



Help
Calculator

Home details	Net equivalent energy usage																					
<table style="width: 100%; border-collapse: collapse;"> <tr> <td style="width: 20%;">Your Project Name</td> <td style="border: 1px solid black; padding: 2px;">WOH Example</td> <td></td> </tr> <tr> <td>State/Territory</td> <td style="border: 1px solid black; padding: 2px;">ACT</td> <td></td> </tr> <tr> <td>NCC Climate zone</td> <td style="border: 1px solid black; padding: 2px;">7</td> <td style="text-align: right; font-size: small;">< Help</td> </tr> <tr> <td>Total Floor area (m²)</td> <td style="border: 1px solid black; padding: 2px;">139</td> <td style="text-align: right; font-size: small;">< Help</td> </tr> <tr> <td>NCC Building classification</td> <td style="border: 1px solid black; padding: 2px;">2 (SOU only)</td> <td></td> </tr> </table>	Your Project Name	WOH Example		State/Territory	ACT		NCC Climate zone	7	< Help	Total Floor area (m ²)	139	< Help	NCC Building classification	2 (SOU only)		<table style="width: 100%; border-collapse: collapse;"> <tr> <td style="width: 20%;">Allowance</td> <td style="border: 1px solid black; padding: 2px; text-align: center; background-color: #d9ead3;">5.1</td> <td></td> </tr> <tr> <td>Actual</td> <td style="border: 1px solid black; padding: 2px; text-align: center; background-color: #5cb85c; color: white;">0.3</td> <td style="text-align: center; font-size: 2em; color: white;">✓</td> </tr> </table>	Allowance	5.1		Actual	0.3	✓
Your Project Name	WOH Example																					
State/Territory	ACT																					
NCC Climate zone	7	< Help																				
Total Floor area (m ²)	139	< Help																				
NCC Building classification	2 (SOU only)																					
Allowance	5.1																					
Actual	0.3	✓																				
Equipment details																						
Space heating/cooling	Pools and spas																					
<p>If using a heat pump specify rating type > Seasonal Star Rating (2019)</p> <p style="text-align: center; margin-left: 100px;">↓</p> <table style="width: 100%; border-collapse: collapse;"> <tr> <td style="width: 15%;"></td> <td style="width: 15%; text-align: center; font-size: small;">Type</td> <td style="width: 15%;"></td> <td style="width: 15%; text-align: center; font-size: small;">Star Rating (2019)</td> <td style="width: 40%;"></td> </tr> <tr> <td style="font-size: small;">Main space conditioning - HEATING</td> <td style="border: 1px solid black; padding: 2px;">Ducted heat pump</td> <td style="border: 1px solid black; padding: 2px;"></td> <td style="border: 1px solid black; padding: 2px;">2.25 to < 3</td> <td style="text-align: right; font-size: small;">< Help</td> </tr> <tr> <td style="font-size: small;">Main space conditioning - COOLING</td> <td style="border: 1px solid black; padding: 2px;">Ducted heat pump</td> <td style="border: 1px solid black; padding: 2px;"></td> <td style="border: 1px solid black; padding: 2px;">< 2.25</td> <td style="text-align: right; font-size: small;">< Help</td> </tr> </table>		Type		Star Rating (2019)		Main space conditioning - HEATING	Ducted heat pump		2.25 to < 3	< Help	Main space conditioning - COOLING	Ducted heat pump		< 2.25	< Help	<table style="width: 100%; border-collapse: collapse;"> <tr> <td style="width: 60%;">Pool volume (L)</td> <td style="border: 1px solid black; width: 40%;"></td> </tr> <tr> <td>Pool pump star rating</td> <td style="border: 1px solid black;"></td> </tr> <tr> <td>Spa volume (L)</td> <td style="border: 1px solid black;"></td> </tr> </table>	Pool volume (L)		Pool pump star rating		Spa volume (L)	
	Type		Star Rating (2019)																			
Main space conditioning - HEATING	Ducted heat pump		2.25 to < 3	< Help																		
Main space conditioning - COOLING	Ducted heat pump		< 2.25	< Help																		
Pool volume (L)																						
Pool pump star rating																						
Spa volume (L)																						
Water heating	Photovoltaics																					
<table style="width: 100%; border-collapse: collapse;"> <tr> <td style="width: 20%;">Main water heater type</td> <td style="border: 1px solid black; padding: 2px;">Heat pump (standard)</td> </tr> </table>	Main water heater type	Heat pump (standard)	<table style="width: 100%; border-collapse: collapse;"> <tr> <td style="width: 60%;">Photovoltaic capacity (kW)</td> <td style="border: 1px solid black; padding: 2px; text-align: center;">3</td> </tr> </table>	Photovoltaic capacity (kW)	3																	
Main water heater type	Heat pump (standard)																					
Photovoltaic capacity (kW)	3																					
<p>Notes:</p> <p>1. This calculator automates the NCC whole-of-home energy usage requirements (Part 13.6 of the ABCB Housing Provisions and J3D14 of NCC Volume One).</p> <p>2. For the purposes of this calculator, floor area is measured within the inside face of the external walls of the sole-occupancy unit (SOU) and includes any conditioned attached Class 10a part.</p>																						



D.6 Artificial lighting

D.6.1 Example 6: Artificial lighting

Introduction

A DTS Solution using the DTS Provisions that form the Elemental compliance option is proposed for an SOU in an apartment building. See Chapter 3 for more information on this compliance option.

The calculations provided are limited to those required for artificial lighting i.e. clause J7D3 (1) of Part J7 Volume One.

This example uses a 75.0 m² SOU with an associated balcony of 10 m² in an apartment building.

There is a calculator available, the ABCB Lighting Calculator, that automates the calculations required for artificial lighting. See the Resource Library on the [ABCB website](#).

Step 1: Calculating the allowance

For lamp power density, the following applies:

- The SOU does not have any control devices or regulators applied to the lighting. The lamp power density is calculated using J7D3(1)(a).
- The SOU wattage allowance is $75 \text{ m}^2 \times 5 \text{ W/m}^2 = 375 \text{ W}$.
- The balcony wattage allowance is $10 \text{ m}^2 \times 4 \text{ W/m}^2 = 40 \text{ W}$.

For illumination power density the following applies:

- Using the same SOU as above and providing a programmable dimmer system to control the lighting for 80% of the living and dining area, and a motion detector to control the lighting in the balcony, the allowance can be adjusted using the illumination power density approach.
- The total area of living and dining area that is controlled by a programmable dimming system is 30 m². The remaining part of SOU without lighting control devices is 45 m².
- For the areas of the SOU that do not have any control devices or regulators applied to the lighting, the allowance is calculated using J7D3(1)(a) and the area.
- The SOU wattage allowance (excluding the living and dining area and balcony) is: $45 \text{ m}^2 \times 5 \text{ W/m}^2 = 225 \text{ W}$
- For living and dining area controlled by programmable dimming system, the allowance is



calculated using J7D3(1)(a), J7D3(1)(b) and the area. From Table J7D3b, the illumination power density adjustment factor for a programmable dimming system is 0.85.

- For balcony area controlled by a motion detector, the allowance is calculated using J7D3(1)(a), J7D3(1)(b) and the area. From Table J7D3b, the illumination power density adjustment factor for a motion detector is 0.6.
- The allowance for living and dining area with the adjustment factor is calculating using Table J7D3b. From Table J7D3b, there is requisite to have 75% of the area of the space controlled by programmable dimmers to qualify for use of it. This is the case for this design.
- The illumination power density allowance after use of adjustment factor for living and dining area is: $5 \text{ W/m}^2 \div 0.85 = 5.9 \text{ W/m}^2$.

This increased the allowance by applying Table J7D3b.

The SOU wattage allowance for living and dining area after use of adjustment factor is: $5.9 \text{ W/m}^2 \times 30 \text{ m}^2 = 177 \text{ W}$.

- Lastly, the allowance for balcony with the adjustment factor is calculating using Table J7D3b.
- The SOU allowance for balcony area is: $4 \text{ W/m}^2 \div 0.6 = 6.7 \text{ W/m}^2$.

This is the increase allowance based on applying Table J7D3b.

The SOU wattage allowance for balcony after use of adjustment factor is: $6.7 \text{ W/m}^2 \times 10 \text{ m}^2 = 67.0 \text{ W}$.

- Therefore, using the illumination power density approach, the overall allowance for the SOU is higher than using the lamp power density approach due to installation of programmable dimmer system as a lighting control device.
- The overall SOU wattage allowance (excludes the balcony) is 402 W (living and dining area 177 W+ other areas 225 W).

Step 2: Calculate the lighting design wattage

The overall lamp power density and illumination power density is calculated by adding the maximum power ratings of all the permanently installed lights (lamps) in a space and dividing them by the area of the space.

This is where all the proposed hardwired light's maximum wattages are added up to achieve a total. Desk lamps, floor lamps and the like that are plugged into general power outlets are not



included; it is only the permanent lighting in a space that is regulated.

Step 3: Compare the wattage of the proposed design to the allowance

If the proposed design is equal to or less than the allowance, then compliance is achieved. If it is over the allowance – reworking of the proposed design is needed to achieve compliance.

In the example above for the SOU, using the—

- lamp power density - compliance is achieved if the proposed design total wattage does not exceed 375 W
- illumination power density - compliance is achieved if a programmable dimming system and a motion detector are used and the proposed design total wattage does not exceed 401 W.

In the example above for the balcony, using the—

- lamp power density, compliance is achieved if the proposed design total wattage does not exceed 40 W
- illumination power density – compliance is achieved if a programmable dimming system and a motion detector are used and the proposed design total wattage does not exceed 67 W.



D.7 J1V4 Verification of building envelope sealing

D.7.1 Example 7: Verification of building envelope sealing – SOUs and the common areas of an apartment building

Introduction

A Performance Solution to satisfy J1P1(e) and J1P2, assessed using Verification Method J1V4 is proposed to verify the air-tightness of the SOUs and common areas of an apartment building.

As per clause A2G2(4) of the NCC, the process for developing Performance Solutions must be followed.

Each SOU needs to be tested individually. The same testing method (Method 1 of AS/NZS ISO 9972) can be used for the SOUs and the common areas of the building.

Where common areas can be separated from SOUs, J1V4 can be used as a pathway; otherwise impact of any adjoining SOUs on the air infiltration rate of the common area also needs to be taken into account.

Step 1: Plan ahead

Since Verification Method J1V4 requires verification through testing, the building and/or design professionals need to ensure that their program of work accounts for the associated risks.

Testing should be performed as soon as possible on completion of the building envelope is complete. This will make it easier to undertake improvements with the required personnel.

One month should be allowed between testing and handover of the building. This is because a second test during this period may be needed if the building fails to meet the 10 m³/hr.m² requirement. This allows enough time for sealing to be improved and retesting to occur.

The air barrier is continuous and needs to be clearly defined and marked on the building's drawings.

Step 2: Quality construction

Although using Verification Method J1V4 means that the DTS Provisions are not mandatory, they can still be used as guidelines. In some areas, departures from the DTS Provisions may be used as they suit an innovative method, so long as the Performance Requirement is satisfied.

Step 3: Prepare for the test

After the building envelope is complete, the building needs to be made suitable for testing. To follow the requirements of AS/NZS ISO 9972 Method 1, closing the SOU and common area



windows, doors, trapdoors, ventilation openings and other openings in the building's envelope is needed. The air terminal devices in the SOUs or common area's ducted air-conditioning system are also sealed so the whole building is treated as a whole system.

Openings in the building's envelope for kitchen and toilet exhaust systems are closed, but not specifically sealed, as these systems are intermittent.

The blower door testing experts will then mount a blower door assembly at the SOU's front door and connect pressure measuring devices to the inside and outside of the building.

Step 4: Test

The blower door testing experts follow the procedures listed in AS/NZS ISO 9972. They check for large leaks and failures of temporarily sealed openings. They record the temperature inside and outside the building, as well as the wind speed.

They also measure the pressure difference between the inside and outside of the building without the blower door providing any airflow, to ensure that this can be accounted for.

The blower door testing experts then turn on the blower door. The test is carried out by taking measurements of blower door air flow rate and indoor/outdoor pressure difference over a range of applied pressure differences in 10 Pa increments.

They repeat this up to 60 Pa, as their attempt to test at 70 Pa proves beyond the capability of their equipment. When pressure differences above 50 Pa can be achieved, the accuracy of the test is enhanced. This is not required by AS/NZS ISO 9972. They repeat this process for both positive and negative pressures.

Step 5: Calculation

The blower door testing experts still need to convert their recordings into an air flow rate at 50 Pa, to verify the results. As part of this process, they refer again to AS/NZS ISO 9972 which sets out the calculations required.

They account for the base pressure difference, convert airflow readings into airflow through the envelope and plot the results to determine the relationship between the airflow through the envelope and induced pressure difference.

By synthesising data from the series of tests as required by the standard, they reduce the error in measurement. The result is calculated as the average result of both positive and negative test results.

Corrections for the environmental conditions universalise the results, so that they can be compared with the requirements of the Verification Method.

Step 6: Test reporting

The blower door testing experts then produce a test report with all the information specified by AS/NZS ISO 9972.



This includes that the test was undertaken using Method 1 of AS/NZS ISO 9972, the status of all building openings, testing apparatus, data, calculations, and results.

Step 7: Check

The building and/or design professionals check the results of the test against the 10 m³/hr.m² requirement. Due to the attention paid to construction and quality assurance, their test results show that the building meets the requirement. If they fell short, then they would return to Step 2, rectify any defects and test again.

If the test results show that an air permeability rate of not more than 5 m³/hr.m² at 50 Pa reference pressure is achieved for any SOU, a mechanical ventilation system must be provided for that SOU, complying with J1V4(2)(a).



Appendix E Examples for common areas

This appendix contains 5 examples to assist with understanding and applying the energy efficiency DTS Provisions and Verifications Methods in the NCC relevant to the common areas of a Class 2 apartment building.

The examples and their location in this appendix are listed and hyperlinked in Table E. 1.

They should be read in conjunction with a copy of NCC Volume One.

Table E. 1 Examples for common areas and their location

Appendix Examples	Page reference
E.1 Building fabric	230 - 239
E.2 Ductwork insulation	240 - 241
E.3 Water pump	242 - 244
E.4 Artificial lighting	245 - 248
E.5 J1V3 Verification using a reference building	249 - 250

E.1 Building fabric

E.1.1 Example 1: Total R-Value Calculation of a stud wall

Introduction

A stud wall consists of 3 mm thick aluminium sheeting, 75 mm thick bulk insulation with an R-Value of 1.5, and 13 mm thick gypsum plasterboard.

The insulation layer is bridged by 75 mm x 35 mm pine framing studs at 600 mm centres, noggings at maximum 1350mm height, and 35 mm height top and bottom plates.

The wall is 2.4 m tall. Bridging calculation is as per NZS 4214:2006. The wall details are illustrated in Figure E. 1.

Figure E. 1 Stud wall section

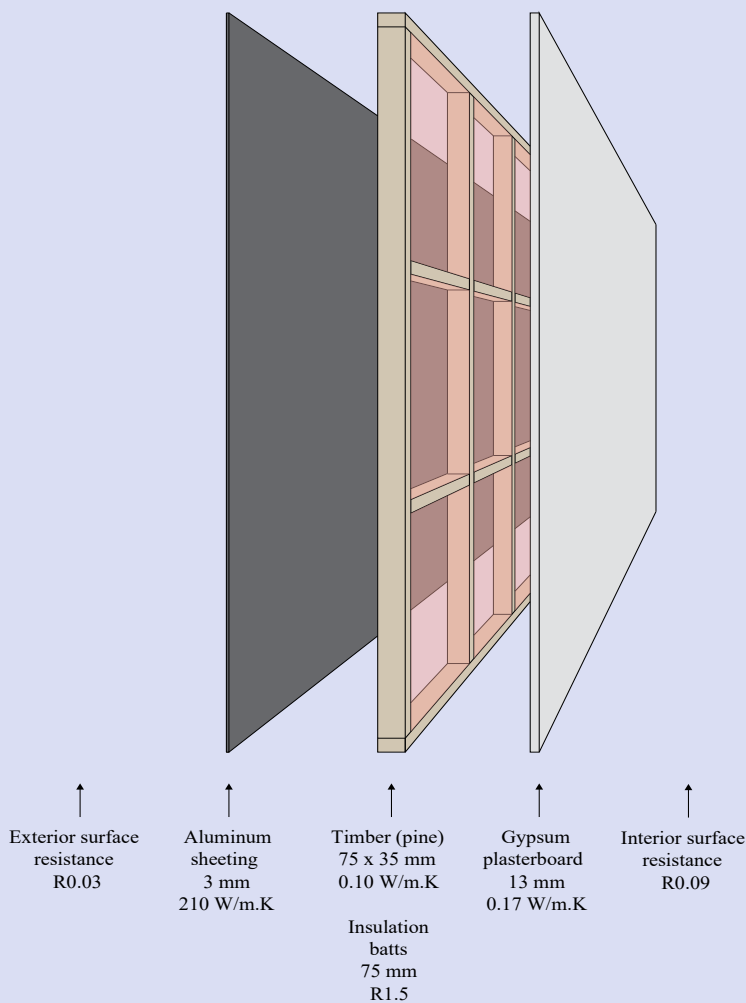



The Total R-Value is calculated by determining the thermal resistance of each layer, surface layer, and any bridged layers in the wall. The bridging calculation (as per NZS 4214:2006) is shown below.

Exterior surface resistance:

See NZS 4214:2006, Section 5.2.

$$R = 0.03 \text{ m}^2.\text{K}/\text{W}$$

Layer 1: 3 mm aluminium sheeting

$$R = \frac{0.03\text{m}}{210\text{W}/\text{m.k}}$$

$$R = 0.00001 \text{ m}^2.\text{K}/\text{W}$$

Layer 2: Insulation with timber thermal bridge

See NZS 4214 Section 5.7.

First the R-values of each material in the layer is determined:

$$R_1 \text{ (75 mm thick R1.5 insulation batts)} = 1.5 \text{ m}^2.\text{K}/\text{W}$$

$$R_2 \text{ (75 mm deep timber framing)} = \frac{0.075\text{m}}{0.10\text{W}/\text{m.K}}$$

$$R_2 \text{ (75 mm deep timber framing)} = 0.75 \text{ m}^2.\text{K}/\text{W}$$

Next, the fraction of the cross-section at right angles to the direction of heat flow occupied by each region in the layer is determined.

One repeated section of the wall can be examined to determine the fraction of each region in the layer as per Figure E. 2.

Figure E. 2 Insulation with framing acting as a thermal bridge

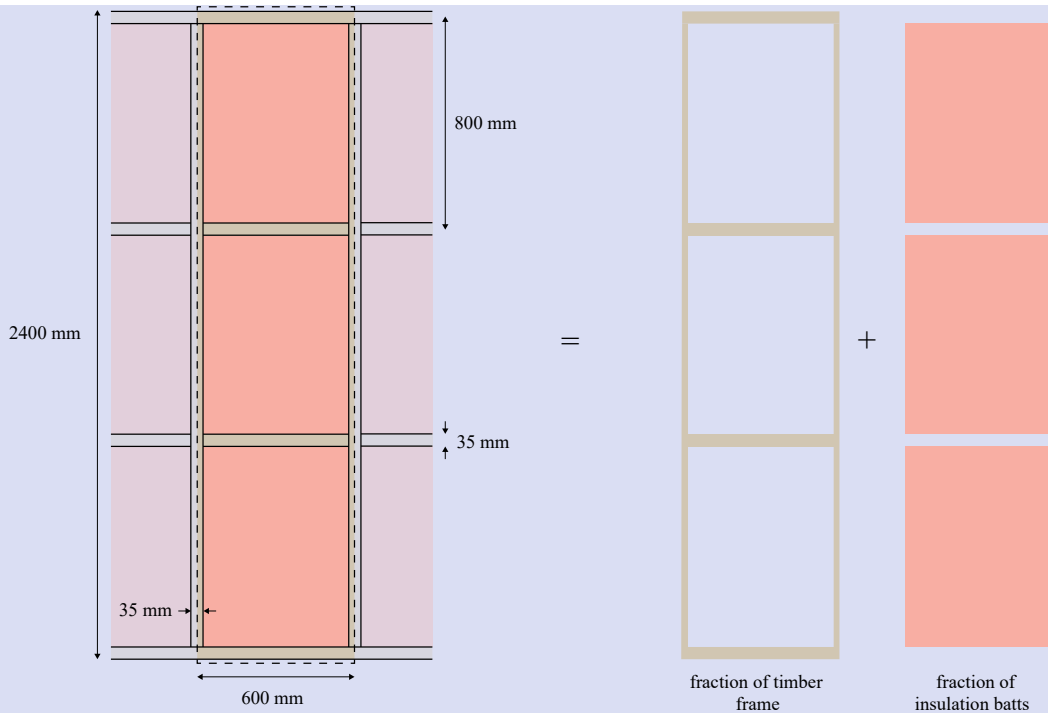

$$f_1(\text{fraction of insulation batts}) = \frac{\text{area of insulation}}{\text{total area}}$$

$$f_1 (\text{fraction of insulation batts}) = \frac{600 \times 2400 - (2400 \times 35 + (600 - 35) \times 35 \times 4)}{600 \times 2400}$$

$$f_1 (\text{fraction of insulation batts}) = 0.8867$$

$$f_2 (\text{fraction of timber framing}) = \frac{\text{area of timber framing}}{\text{total area}}$$

$$f_2 (\text{fraction of timber framing}) = \frac{2400 \times 35 + (600 - 35) \times 35 \times 4}{600 \times 2400}$$

$$f_2 (\text{fraction of timber framing}) = 0.1133$$

Next the total resistance of the layer is calculated.

See Equation 5 and 6 of NZS 4214:

$$\frac{1}{R} = \frac{f_1}{R_1} + \frac{f_2}{R_2} = \frac{0.8867}{1.5} + \frac{0.1133}{0.75} = 0.742$$

$$R = \frac{1}{0.742}$$

$$R = 1.347 \text{ m}^2.\text{K/W}$$

**Layer 3: 13 mm gypsum plaster board**

$$R = \frac{0.013 \text{ m}}{0.17 \text{ W/m.K}}$$
$$= 0.076 \text{ m}^2.\text{K/W}$$

Interior surface resistance:

See NZS 4214 Section 5.2.

$$R = 0.09 \text{ m}^2.\text{K/W}$$

Total thermal resistance (Total R-Value):

The total thermal resistance is the sum of all the layers, the surface layers and any bridge layers (i.e. layer 2).

$$\text{Total R-Value} = 0.03 + 0.00001 + 1.347 + 0.076 + 0.09$$

$$\text{Total R-Value} = 1.544 \text{ m}^2.\text{K/W}$$

Please note this calculated Total R-Value is representative of the wall where the timber frame and insulation batts are consistent with the area used in this example. The areas on the edge of the wall, for example, would therefore have a different Total R-Value as the fraction of timber would be larger due to the edge stud components.

E.1.2 Example 2: Wall-glazing construction Total System U-Value calculation**Introduction**

Wall-glazing constructions refer to the combination of wall and glazing components that make up the envelope of a building. They exclude display glazing and opaque non-glazed openings such as doors, vents, penetrations and shutters.

The following wall-glazing construction is facing north. As the wall glazing-construction is facing only the northern aspect, the single aspect calculation method (Method 1, S37C5) can be used.

The wall-glazing construction is part of an apartment building and is in climate zone 7. The U-Value of the glazing is equal to U3.5.

Figure E.3 Window to wall ratio

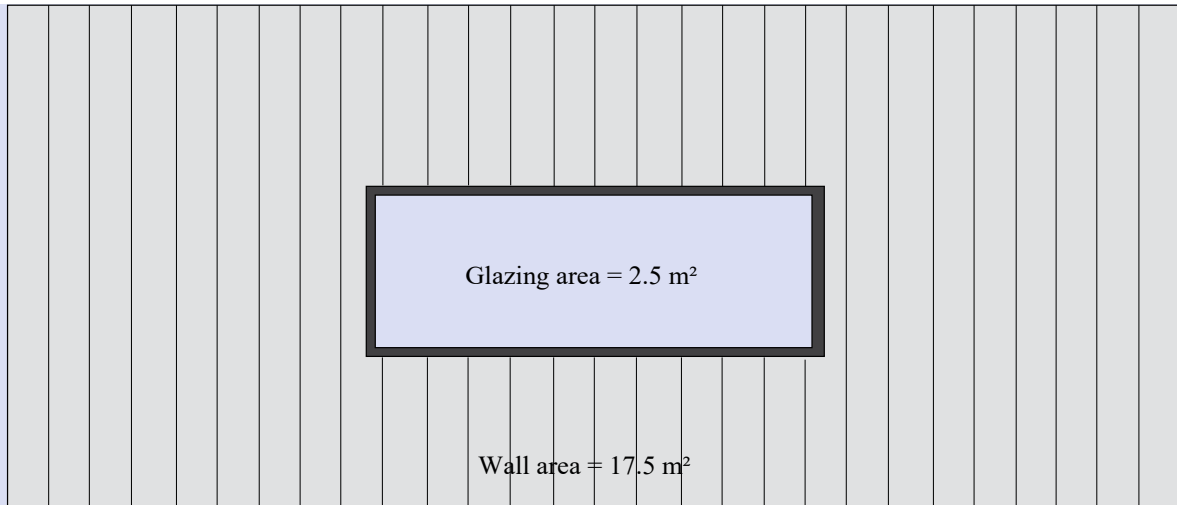

The wall component is a stud wall that is made up of 3 mm thick aluminium sheeting, bulk insulation with an R-Value of 1.5, 13 mm thick plasterboard. The Total R-Value is 1.54.

Wall construction R-Value:

The Total R-Value of 1.54 is calculated in accordance with AS/NZS 4859.2, with allowances for thermal bridging.

Please note the ABCB Façade Calculator provides a Total System R-Value Calculator that enables the input of material layers and determines the Total R-Value with allowances for thermal bridging in accordance with AS/NZS 4859.2.

The percentage area of the wall component can be calculated as the area of the wall component divided by the total area:

$$17.5 / 20 = 0.875 \text{ or } 87.5\%$$

As the percentage of wall area is greater than 80% of the wall-glazing construction, the minimum R-Value is specified in Table J4D6a.

Per Table J4D6a, the minimum requirement for an apartment building in climate zone 7 is R1.4.

As 1.54 is greater than R1.4 the wall component meets the requirements of J4D6(4).

Wall construction U-Value:

The Total System U-Value of the wall component can be calculated as the inverse of the Total R-Value.

$$\text{Total System U-Value} = 1 / 1.54 = 0.65$$

Total System U-Value:

The Total System U-Value of the wall-glazing construction is calculated as the area weighted average of the Total System U-Value of each component.



The percentage area of the wall component is equal to 87.5% as calculated above.

The percentage area of the glazing component can be calculated as the area of the glazing component divided by the total area:

$$2.5 / 20 = 0.125 \text{ or } 12.5\%$$

The area weighted average is then calculated by multiplying the percentage area by the U-Value of each component and adding them together:

$$\begin{aligned} \text{Percentage wall} \times \text{wall U-Value} + \text{Percentage glazing} \times \text{glazing U-Value} = \\ (0.875 \times 0.65) + (0.125 \times 3.5) = 1.00 \end{aligned}$$

Result

As the Total System U-Value (1.00) does not exceed the requirements of J4D6(1)(a) (that the Total System U-Value is no greater than U2.0 for an apartment building), the wall-glazing construction meets J4D6 and Specification 37 requirements.

E.1.3 Example 3: Solar admittance (single aspect)

Introduction

Clause S37C5 specifies the calculation method of solar admittance for single aspect. The calculated solar admittance of the construction must be less than or equal to the applicable value in J4D6(5).

The following example is a north facing wall of a Class 3 building in climate zone 2. The SHGC of the proposed glazing is 0.45. Consider the example illustrated in Figure E.4 below, where:

$$\begin{aligned} G &= 0.6 \text{ m} \\ P &= 0.8 \text{ m} \\ H &= 2.0 \text{ m} \end{aligned}$$

Figure E.4 Window to wall ratio and shading

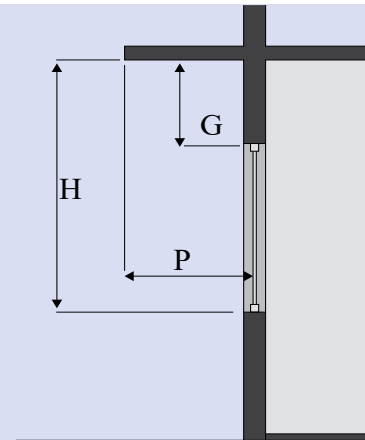
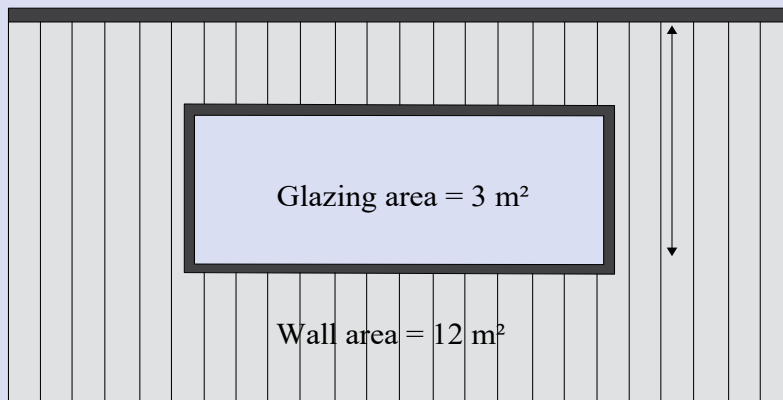

Area of each glazing element (AW)

As there is only one glazing element, $A_{W1} = 3.0 \text{ m}^2$

Shading multiplier of each glazing element (SW)

To determine the shading multiplier, G/H and P/H must first be calculated.

$$G/H = 0.6 / 2 = 0.3$$

$$P/H = 0.8 / 2 = 0.4$$

The shading multiplier can be found in Table S37C7a of Specification 37 and is therefore, 0.89.

$$S_{W1} = 0.89$$

SHGC of each glazing element (SHGC_{W1})

$$SHGC_{W1} = 0.45$$

Area of the wall-glazing construction (A_{Wall})

$$A_{Wall} = 15 \text{ m}^2$$

Calculation of solar admittance

The values determined can now be used in the solar admittance equation provided in Specification 37 Clause S37C5.

$$SA = \frac{A_{W1} \times S_{W1} \times SHGC_{W1}}{A_{Wall}}$$

$$SA = \frac{3.0 \times 0.89 \times 0.45}{15}$$

$$SA = 0.080$$

The calculated solar admittance must be less than or equal to the values specified in J4D6(5).



For an apartment building common area, the maximum solar admittance factor is found in Table J4D6b and is determined to be 0.13.

Result

As the calculated solar admittance of 0.080 does not exceed the applicable value in J4D6(5)(a), which equals 0.13. Therefore, the proposed design meets the requirements.

E.1.4 Example 4: Solar admittance (multiple aspects)

Introduction

Clause S37C6 specifies the method of calculation (Method 2) of solar admittance for multiple aspects. This method specifies the solar admittance for a wall-glazing construction facing multiple aspects. Note that aspects may also be considered separately using Method 1. Method 2 requires a representative air-conditioning energy value less than that achieved by a reference case. The following example is for an apartment building located in climate zone 5.

The solar admittance for each aspect has been pre-determined for the proposed building in accordance with S37C5, Specification 37 (Method 1). The solar admittance is based on a SHGC of 0.30 for all glazing. There is an external shading projection of 0.2 m.

The solar admittance does not meet the requirements for Method 1 on the northern aspect. Therefore, Method 2 is to be used to see if overall compliance can be met for the whole building.

Figure E. 5 Window to wall ratio (multiple aspects)

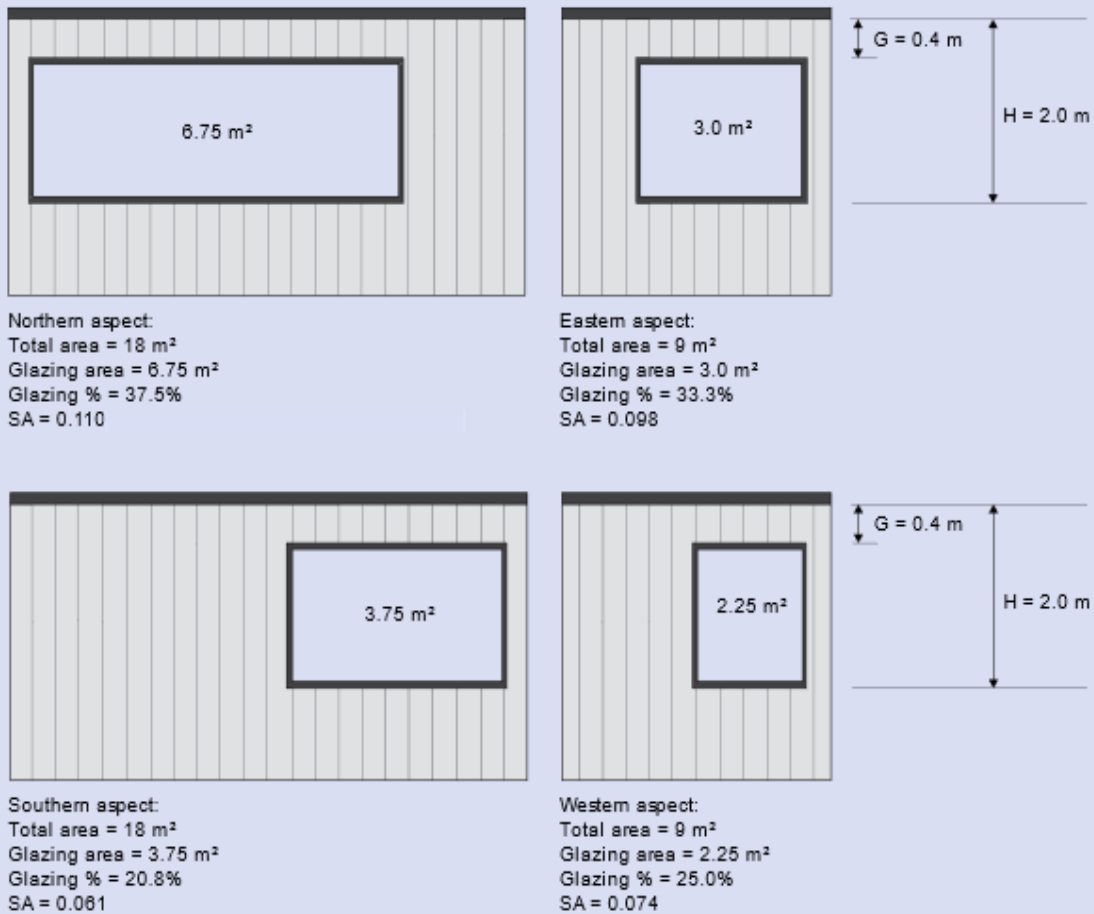

Solar admittance weighting coefficient ($\alpha_{N, E, S, W}$)

The solar admittance weighting coefficient of each aspect is based on the percentage of glazing area per each aspect. If the glazing area is greater than or equal to 20%, the weighting coefficients are listed in Tables S37C6a and S37C6b in S37C6.

As the percentage of glazing is greater than 20% on each aspect, the solar admittance weighting coefficients can be found in Tables S37C6a and S37C6b. For this example, the solar admittance weighting coefficients are found in Table 6b for an apartment building.

For an apartment building in climate zone 5:

The northern aspect solar admittance weighting coefficient (α_N) = 2.28

The eastern aspect solar admittance weighting coefficient (α_E) = 1.72

The southern aspect solar admittance weighting coefficient (α_S) = 1.00

The western aspect solar admittance weighting coefficient (α_W) = 1.75

Wall-glazing construction solar admittance ($SA_{N, E, S, W}$)

Reference case:



Values for the wall-glazing construction solar admittance for the reference case are found in J1.5(e):

$$S_{AN} = 0.13$$

$$S_{AE} = 0.13$$

$$S_{AS} = 0.13$$

$$S_{AW} = 0.13$$

Proposed case:

The values for wall-glazing construction solar admittance for the proposed case are calculated in accordance with Clause J4D6(5)(a) and in this example, are pre-determined. See examples of this method in the example above.

$$S_{AN} = 0.11$$

$$S_{AE} = 0.098$$

$$S_{AS} = 0.061$$

$$S_{AW} = 0.074$$

Representative air-conditioning energy value (E_R)

Reference case:

$$E_R = A_N \alpha_N S_{AN} + A_E \alpha_E S_{AE} + A_S \alpha_S S_{AS} + A_W \alpha_W S_{AW}$$

$$E_R = (18 \times 2.28 \times 0.13) + (9 \times 1.72 \times 0.13) + (18 \times 1.00 \times 0.13) + (9 \times 1.75 \times 0.13)$$

$$E_R = 11.74$$

Proposed case:

$$E_R = (18 \times 2.28 \times 0.11) + (9 \times 1.72 \times 0.098) + (18 \times 1.00 \times 0.061) + (9 \times 1.75 \times 0.074)$$

$$E_R = 8.29$$

Result

As the proposed case representative air-conditioning energy value (8.29) is less than that of the reference case (11.74), the wall-glazing construction meets the requirements for Method 2.

E.2 Ductwork insulation

E.2.1 Example 5: Ductwork insulation

Introduction

This example illustrates the application of the ductwork insulation requirements, which are set out in Clause J6D6. The proposed apartment building is located in Perth (climate zone 5) and the ductwork is greater than 3 m in length. Figure E.6 shows a plan view of the ductwork layout for the building. Space A is an unconditioned space. Spaces B and C are conditioned spaces

Figure E. 6 Ductwork plan

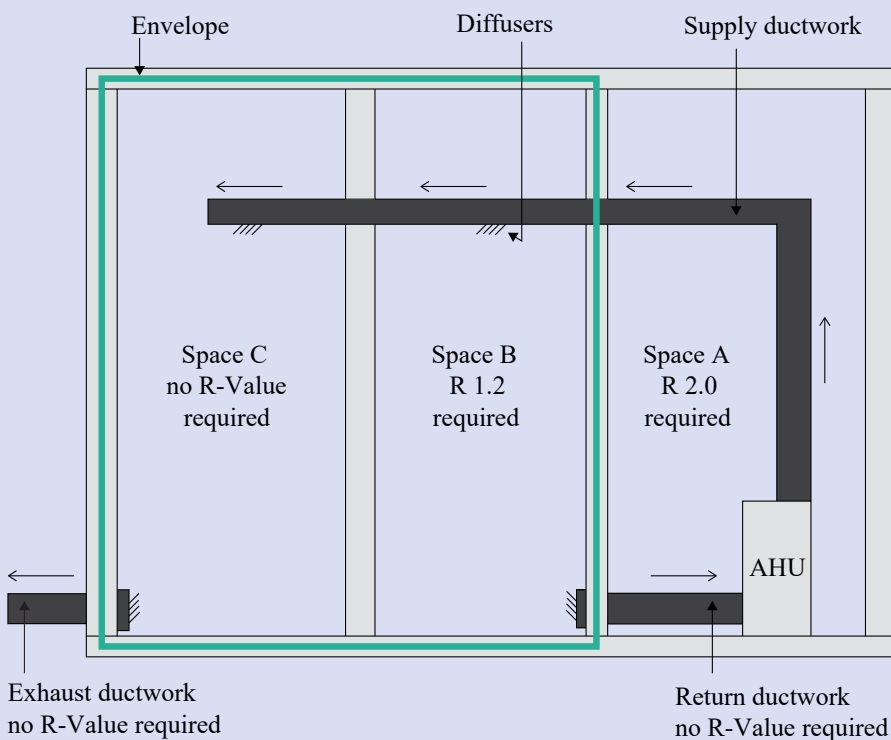

Step 1: Identify the spaces that contain ductwork

The first step is to consider which spaces in the building contain ductwork. As you can see from Figure E.6, Spaces A, B and C all contain ductwork.

**Step 2: Identify which spaces (containing ductwork) are conditioned or unconditioned**

Space A is not conditioned. Spaces B and C are conditioned.

Step 3: Apply the Clause J6D6 provisions

Given what we know about this building, we can then apply the ductwork insulation requirements set out in Clause J6D6.

Space A is not conditioned. Therefore, insulation must be installed to the supply and return ductwork with a minimum R-value of R 2.0 as per Table J6D6.

Space B is a conditioned space. This means that insulation with a minimum added R-Value of R 1.2 from Table J6D6 is required to be installed on the supply ductwork. No insulation is needed for the return ductwork in Space B as it is exempted by Table J6D6(3)(c).

Space C is a conditioned space. Since it is the last room served by the system, the insulation requirements of J6D6(1) do not apply to the ductwork.

In Space B and C, the diffuser forms the interface with the conditioned space and is therefore exempt from the insulation requirements of J6D6(1) by J6D6(3)(b).

The exhaust ductwork is exempt from the insulation requirements of J6D6(1) by J6D6(3)(d).

Notes

Note that the requirements of Section C (Fire resistance) in NCC Volume One may also apply.

E.3 Water pump

E.3.1 Example 6: A chilled water pump located in an apartment building

Introduction

Consider a chilled water pump located in a Class 2 apartment building. The chilled water pump operates for approximately 12 hours a day with a fluid temperature of 6°C. The pumps water flow rate is 17.1 L/s. The system head is 300 kPa and the efficiency at the BEP is 75%.

The Minimum Efficiency Index of the pump is equal to 0.55 when calculated in accordance with European Union Commission Regulation No. 547/2012.

The pipe system is a distributive variable speed system. The straight segments of pipework along the index can be represented with the following diagram.

Figure E.7 Ductwork section

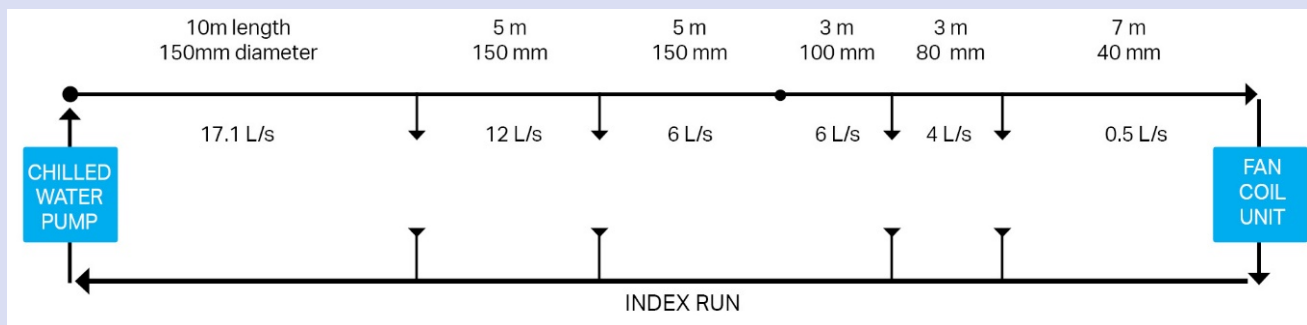

5: Copper Type B to AS1432, 80 mm diameter, 3 m length, 0.0015 mm roughness, 4 L/s flow rate, 134.8 Pa/m pressure drop

6: Copper Type B to AS1432, 40 mm diameter, 7 m length, 0.0015 mm roughness, 0.5 L/s flow rate, 104.8 Pa/m pressure drop

7: Copper Type B to AS1432, 40 mm diameter, 7 m length, 0.0015 mm roughness, 0.5 L/s flow rate, 104.8 Pa/m pressure drop

8: Copper Type B to AS1432, 80 mm diameter, 3 m length, 0.0015 mm roughness, 4 L/s flow rate, 134.8 Pa/m pressure drop

9: Copper Type B to AS1432, 100 mm diameter, 3 m length, 0.0015 mm roughness, 6 L/s flow rate, 66.5 Pa/m pressure drop

10: Copper Type B to AS1432, 150 mm diameter, 5 m length, 0.0015 mm roughness, 6 L/s flow rate, 9.3 Pa/m pressure drop



11: Copper Type B to AS1432, 150 mm diameter, 5 m length, 0.0015 mm roughness, 12 L/s flow rate, 31.9 Pa/m pressure drop

12: Copper Type B to AS1432, 150 mm diameter, 10 m length, 0.0015 mm roughness, 17.1 L/s flow rate, 60.1 Pa/m pressure drop

Note that the pressure drop across each component has been calculated using a pipe friction loss chart.

As per J6D8(1), pumps and pipework that form part of an air-conditioning system must either separately comply with the requirements of J6D8(2) to (4) or achieve whole of system compliance (i.e. the proposed pumps and pipework achieve a pump motor input power lower than that of a system designed to meet the DTS requirements of J6D8(2) to (4).

The following example will be checked at a component level. Please note the Pump System Calculator determines if compliance is met at both a component and system level.

Step 1: Circulator pumps

J6D8(2) details requirements for the EEI for circulator pumps that must be met to achieve component compliance (i.e. J6D8(1)(a)).

Circulator pumps are glandless impeller pumps used in a closed loop system with a rated hydraulic power output below 2.5 kW.

The EEI must be calculated in accordance with European Union Commission Regulation No. 622/2012. The ABCB's Pump System Calculator, that is available from the [ABCB website](#), calculates the EEI using this method.

However, as the specified pump in the example is not a circulator pump this requirement is not relevant.

Step 2: Other pumps

J6D8(c) details requirements for the Minimum Efficiency Index of other pumps that must be met to achieve component compliance (i.e. J6D8(1)(a)).

Other pumps refer to pumps not covered by J6D8(2) (i.e. pumps that are not circulator pumps).

The Minimum Efficiency Index must be calculated in accordance with European Union Commission Regulation No. 547/2012. The ABCB's Pump System Calculator calculates the Minimum Efficiency Index using this method.

As the Minimum Efficiency Index (0.55) is greater than the minimum of 0.4 that is specified in J6D8(3), compliance is met with J6D8(3).

Please note the Pump System Calculator will determine the Minimum Efficiency Index in accordance with European Union Commission Regulation No. 547/2012 for component level compliance. However, if a whole of system check is required under J6D8(1)(b), an alternate



method is used. This method uses the procedure within EU Commission Regulation No. 547/2012 to compute the required efficiency and compare it with the actual efficiency.

Step 3: Pipework

J6D8(4) specifies average maximum pressure drops for straight segments of pipework along the index run that must be met to achieve component compliance (i.e. J6D8(1)(a)).

As the pipework is a distributive variable speed system, the pressure drop of straight segments of pipework must not be more than the values nominated in Table J6D8d.

The operating hours per annum for a system that operates for approximately 12 hours a day fall between 2000 and 5000 hours (multiply the operating hours per day by the number of days in operation to determine the number of hours per annum).

Table J6D8d specifies that all nominal pipe diameters for the above range in hours have an average maximum allowable pressure drop of 400 Pa/m.

As pipes 1 to 6 have pressure drops below that specified in Table J6D8(5) (400 Pa/m), compliance is evidently met with the requirements of J6D8(4). If the segments of pipework do not all meet the requirements of the maximum allowable pressure drop, the average pressure drop is calculated by summing the pressure drop (Pa) of each segment of pipe and dividing this by the total length of all segments; as follows:

$$\frac{2 \times (60.1 \times 10 + 31.9 \times 5 + 9.3 \times 5 + 66.5 \times 3 + 134.8 \times 3 + 104.8 \times 7)}{2 \times (10 + 5 + 5 + 3 + 3 + 7)}$$

$$\text{verage pressure drop} = 65.0 \text{ Pa/m}$$

Step 4: Exemptions

Valves and fittings are exempt from the pipework requirements J6D8(4).

The smallest pipe size compliant with J6D8(4) for each segment pipework would result in a velocity of greater than 0.7 m/s. Therefore, no segments of pipework are exempt from the requirements of J6D8(4).

Result:

As the components of the pump system meet the compliance requirements of J6D8(3) and (4) (excluding J6D8(2)) as the pump is not a circulator pump) the pump system complies on a component level.

Where the system is considered complex or does not meet individual component compliance but may meet whole of system compliance, the ABCB Pump System Calculator can provide a quicker way to undertake the calculations.



E.4 Artificial lighting

E.4.1 Example 7: Illumination power load for a corridor in common area

Introduction

A corridor is 5 m by 7 m, therefore its floor area is 35 m² and the perimeter is 24 m. The ceiling is 2.6 m high. The lighting design has a proposed aggregate design illumination power load (load for all lighting fittings) of 300 W which includes all ballasts. The design incorporates a programmable dimming system which operates all the lights as a single block.

Design:

The design illumination power load is 250 W.

Step 1: Allowance

From Table J7D3a, the maximum illumination power density allowed for a corridor of Class 2 building is 4.5 W/m².

Step 2: Adjustment factors

From Table J7D3a, the illumination power density adjustment factor for a programmable dimming system that controls at least 75 percent of the floor area is 0.85.

From J7D3a Note 3, the adjustment factor for room size depends upon the room aspect ratio (see J6.2a, below for more detail on room aspect ratio adjustments):

$$\text{Room aspect ratio} = \frac{A}{H \times C}$$

Where:

A = the area of the enclosed space

H = the height of the space measured from the floor to the highest part of the ceiling

C = the perimeter of the enclosed space

Therefore, the room aspect ratio is:

$$\text{Room aspect ratio} = \frac{35}{2.6 \times 24} = 0.56$$



Since the room aspect ratio is less than 1.5, Note 2 of Table J7D3a allows an adjustment factor for room aspect. The factor is calculated as:

$$\text{Adjustment factor} = 0.5 + \frac{\text{room aspect ratio}}{3} = 0.5 + \frac{0.56}{3} = 0.69$$

To determine the new allowance the maximum illumination power density for a laboratory from Table J7D3a is divided by the adjustment factor calculated above.

This means 4.5 W/m² is divided by 0.69 to give 6.52 W/m².

Note 4 of Table J7D3a allows the adjustment factor from Table J7D3b for the programmable dimming system to be applied in addition to the adjustment for room aspect. The new allowance then becomes:

$$6.52 / 0.85 = 7.67 \text{ W/m}^2$$

Step 3: Illumination power load allowance

The illumination power load allowance is space area x maximum illumination power density, which is 35 x 7.63 = 268.5 W

Step 4: Result

As the aggregate design illumination power load of 250 W is less than the illumination power load allowance of 269 W, the design complies.



E.4.2 Example 8: Illumination power load of a common area in a Class 2 building

Introduction

A common area in an apartment building is 15 m by 2 m, therefore its floor area is 30 m² and the perimeter is 34 m. The ceiling is 2.8 m high. The lighting design has a proposed aggregate design illumination power load (load for all lighting fittings) of 150 W.

The common area has incorporated a motion detector and lumen depreciation dimming. The common area is fitted with LED lighting with a CRI of 90 and a CCT of 3000 K.

Design

The design illumination power load is 150 W.

Step 1: Allowance

From Table J7D3a, the maximum illumination power density allowed for a corridor of Class 2 building is 4.5 W/m².

Step 2: Adjustment factors

Room Aspect Ratio:

From Table J7D3a Note 3, the adjustment factor for room size depends upon the room aspect ratio:

$$\text{Room aspect ratio} = \frac{A}{H \times C}$$

Where:

A = the area of the enclosed space

H = the height of the space measured from the floor to the highest part of the ceiling

C = the perimeter of the enclosed space

Therefore, the room aspect ratio is:

$$\text{Room aspect ratio} = \frac{30}{2.8 \times 34} = 0.315$$

Since the room aspect ratio is less than 1.5, Note 2 of Table J7D3a allows an adjustment factor for room aspect. The factor is calculated as:

$$\text{Adjustment factor} = 0.5 + \frac{\text{room aspect ratio}}{3} = 0.5 + \frac{0.315}{3} = 0.605$$



Therefore, the room aspect ratio adjustment factor is 0.61.

Table J7D3b adjustment factors:

Note 4 of Table J7D3a allows adjustment factors from Table J7D3b for control devices.

Two adjustment factors apply for the lounge including the factors for:

- motion detectors where a group of light fittings serving less than 100 m² is controlled (0.6).
- lumen depreciation dimming (0.85).

As per note 1, a maximum of two adjustment factors for a control device can be applied to an area using the following formula:

$A \times (B + [(1 - B) / 2])$ simplified as $A \times (B/2 + 0.5)$

Where:

- A is the lowest applicable adjustment factor; and
- B is the second lowest applicable adjustment factor.

The two lowest applicable adjustment factors are for the motion detectors and lumen depreciation dimming are 0.6 and 0.85, respectively.

Therefore, in combination, the control device adjustment factor is calculated as:

$$0.6 \times (0.85/2 + 0.5) = 0.56$$

Therefore, the control device adjustment factor is 0.56.

Two adjustment factors can be applied from Table J7D3c based on the room lighting design. As the CRI is equal to 90 an adjustment factor of 0.9 can be applied, and as the CCT is less than 3500 K an adjustment factor of 0.8 can also be applied.

All adjustment factors can now be applied to the illumination power density of 4.5 W/m² specified in Table J7D3a. The new allowance then becomes:

$$4.5 / (0.61 \times 0.56 \times 0.9 \times 0.8) = 18.61 \text{ W/m}^2$$

Step 3: Illumination power load allowance

The illumination power load allowance is space area x maximum illumination power density, which is $30 \times 18.61 = 558 \text{ W}$

Result

As the aggregate design illumination power load of 150 W is less than the illumination power load allowance of 558 W, the design complies.



E.5 J1V3 Verification using a reference building

E.5.1 Example 9: Using Verification Method J1V3

Introduction

A Performance Solution to satisfy J1P1, assessed using Verification Method J1V3 is proposed for the common areas of a three storey Class 2 building located in Melbourne.

In this case, the building will have the minimum amount of insulation for the fabric that is required by the DTS Provisions. The services will have energy efficiency parameters above the minimum standard required by the DTS Provisions.

The relevant NCC references are Volume One J1V3. The additional requirements are specified in Specification 33. The required modelling parameters for J1V3 are specified in Specification 34. The calculation method must comply with ANSI/ASHRAE Standard 140. The following calculations are required.

Step 1: Work out the theoretical annual GHG emissions of the reference building

A theoretical reference building is modelled with the minimum DTS Provisions for the fabric and services. For the purposes of this example, the annual GHG emissions of the reference building are calculated at 32 kgCO₂-e/m².annum. This is the allowance.

Step 2: Work out the annual GHG emissions of the proposed building

The annual GHG emissions of the proposed building with the proposed services is calculated to be 30 kgCO₂-e/m².annum.

Step 3: Model the theoretical annual GHG emissions of the proposed building with the services modelled to the minimum DTS Provisions

The annual GHG emissions of the proposed building with the services modelled to the minimum DTS Provisions is calculated to be 35 kgCO₂-e/m².annum.

Step 4: Compare the outcomes of step 2 and step 3 to the allowance in step 1

By comparing the outcome of step 2 and step 3 with the allowance determined in step 1, we can determine whether the design complies with Verification Method J1V3. The criteria in the J1V3 Verification Method states that annual GHG emissions of both cases modelled (step 2 and step 3) must be equal to or less than the allowance calculated in step 1.

The proposed building with the proposed services has GHG emissions of 30 kgCO₂-e/m².annum (step 2). This is less than the allowance 32 kgCO₂-e/m².annum determined in step 1 and therefore meets the first criteria of J1V3(1)(a)(i) for Verification Method J1V3.

30 kgCO₂-e/m² (step 2) < 32 kgCO₂-e/m² (step 1) = ✓



The proposed building with the services modelled to minimum DTS Provisions (step 3) is greater than the allowance 32 kgCO₂-e/m².annum determined in step 1. Therefore, the proposed building's annual GHG emissions are greater than the annual GHG emissions of the reference building and so does not comply with the second criteria in J1V3(1)(a)(ii).

35 kgCO₂-e/m² (step 3) > 32 kgCO₂-e/m² (step 1) = **X**

It is worth noting that although the performance of the proposed services was above that required by the minimum DTS Provisions, the performance of the building's fabric cannot be reduced (traded away) below the minimum required by the DTS Provisions.

Step 5: Results

This means the design does not comply with the Performance Requirement J1P1 using Verification Method J1V3 and will require either an alternative design to be developed or the use of a different Assessment Method.



Appendix F Relevant reports and standards

- ABCB (2023) Condensation in Buildings Handbook.
- ABCB (2019) Energy Efficiency NCC Volume One Handbook.
- ABCB (2023) Housing Energy Efficiency Handbook
- ABCB (2023) Indoor Air Quality Verification Methods Handbook.
- ABCB (2022) Standard – NatHERS Heating and Cooling Load Limits, Version 2022.1
- ABCB (2022) Standard – NCC 2022 Housing Provisions.
- ABCB (2022) Standard – Whole-of-Home Efficiency Factors.
- ANSI/ASHRAE (2020) ANSI/ASHRAE Standard 140 Standard method of test for the evaluation of building energy analysis computer programs.
- ASTM International (2016) ASTM-E96 Standard Test Methods for Water Vapor Transmission of Materials (Procedure B – Water Method).
- Energy Efficient Strategies Pty Ltd (2022) NCC 2022 Update: Whole-of-home Component.
- European Union Commission Regulation (2012) No. 622.
- European Union Commission (2012) No. 547.
- New Zealand Standard 4214 (2006) Methods of Determining the total thermal resistance of parts of buildings.
- Standards Australia (2004) AS 1432 Copper tubes for plumbing, gasfitting and drainage applications.
- Standards Australia (2014) AS 2047 Windows and external glazed doors in buildings (incorporating amendments 1 and 2).
- Standards Australia (2015) AS 3999 Bulk thermal insulation – installation.
- Standards Australia (2021) AS 4254.1 Ductwork for air-handling systems in buildings Part 1: Flexible duct.
- Standards Australia (2012) AS 4254.2 Ductwork for air-handling systems in buildings Part 2: Rigid duct.
- Standards Australia (2013) AS/NZS 5601.1 Gas installations Part 1: General installations.
- Standards Australia (2021) AS/NZS 4234 Heated water systems — Calculation of energy consumption.
- Standards Australia (2021) AS/NZS 5033 Installation and safety requirements for photovoltaic (PV) arrays.
- Standards Australia (2017) AS/NZS 4200.1 Pliable building membranes and underlays Part 1: Materials (incorporating amendment 1).



- Standards Australia (2018) AS/NZS 4859.1 Thermal insulation materials for buildings Part 1: General criteria and technical provisions.
- Standards Australia (2018) AS/NZS 4859.2 Thermal insulation materials for buildings Part 1: Design.
- Standards Australia (2012) AS 1668.2 The use of ventilation and air-conditioning in buildings Part 2: Mechanical ventilation in buildings.
- Standards Australia (2015) AS/NZS ISO 9972 Thermal performance of buildings — Determination of air permeability of buildings — Fan pressurization method.
- Tony Isaacs Consulting Pty Ltd (2022) Principles and methodology for setting NCC heating and cooling load intensity limits & draft heating and cooling load intensity limits for all NatHERS climates.
- Tony Isaacs Consulting Pty Ltd (2022) Technical Report: DTS Elemental Provisions for NCC 2022.
- University of Wollongong (2022) Repeating Thermal Bridges in Ceilings and Floors: Simulation and Calculation: Stage 1 Final Report.
- University of Wollongong (2022) Repeating Thermal Bridges in Ceilings and Floors: Modified Calculation Method: Stage 2 Final Report.